

alea

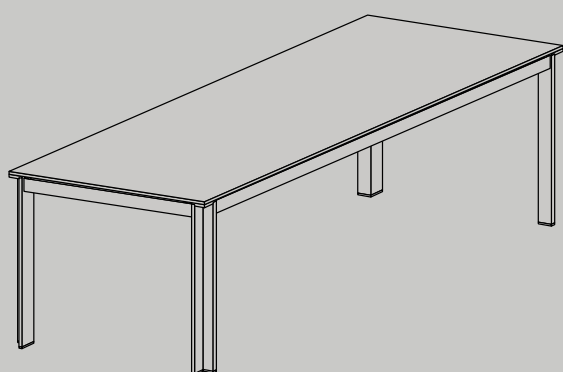

ZEFIRO

operativi | workstations | systemes | operativos

why zefiro

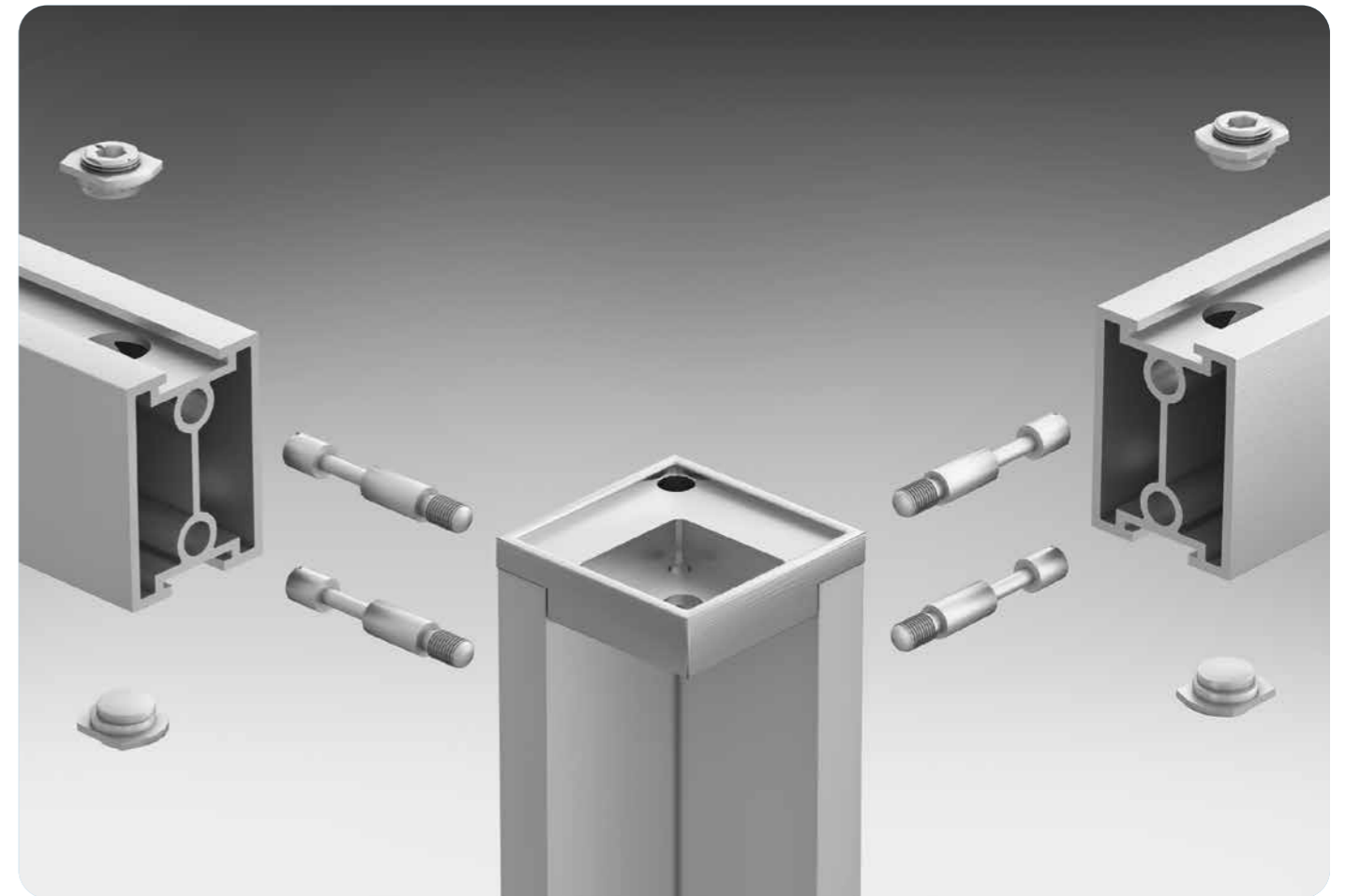
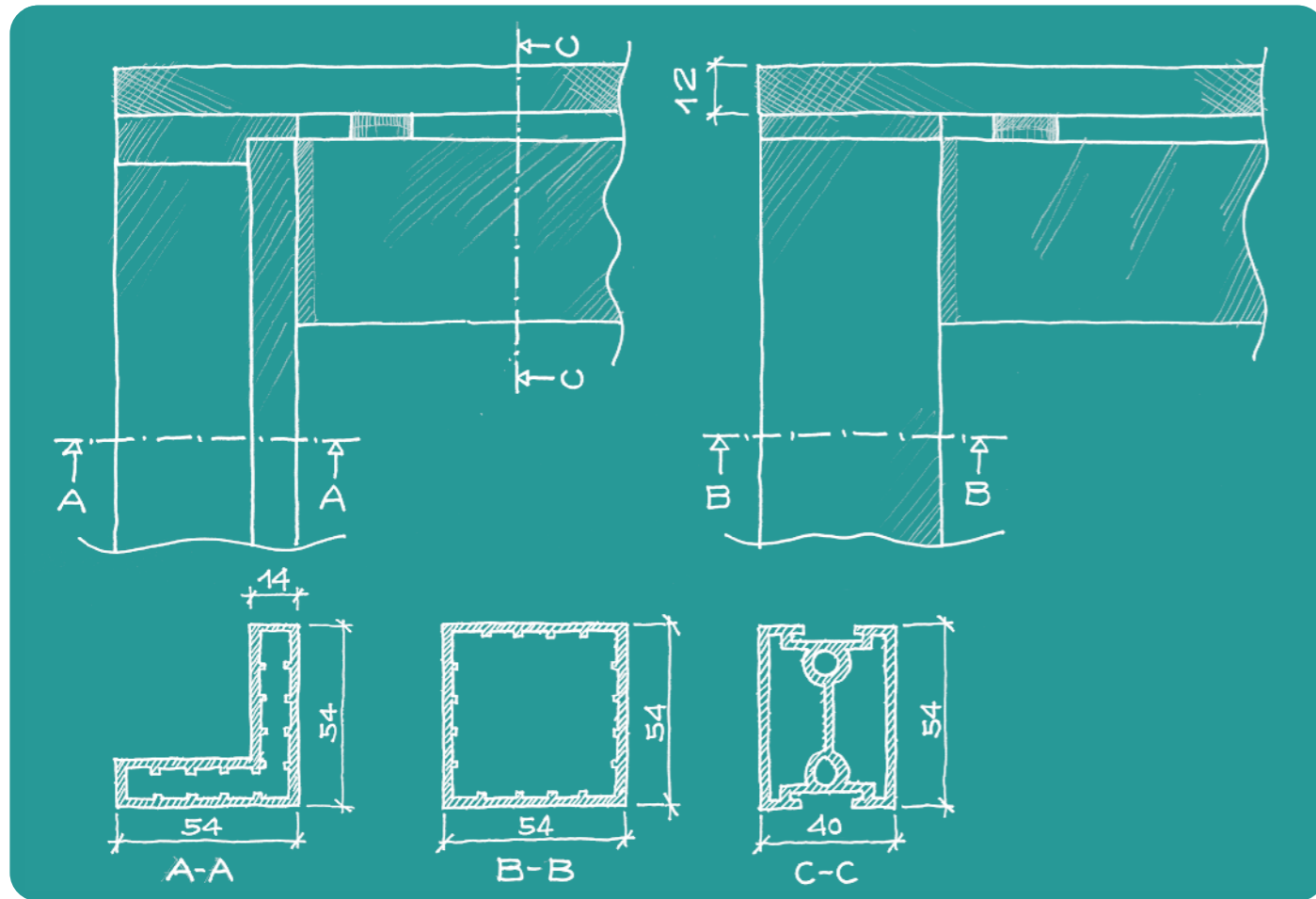

geometry

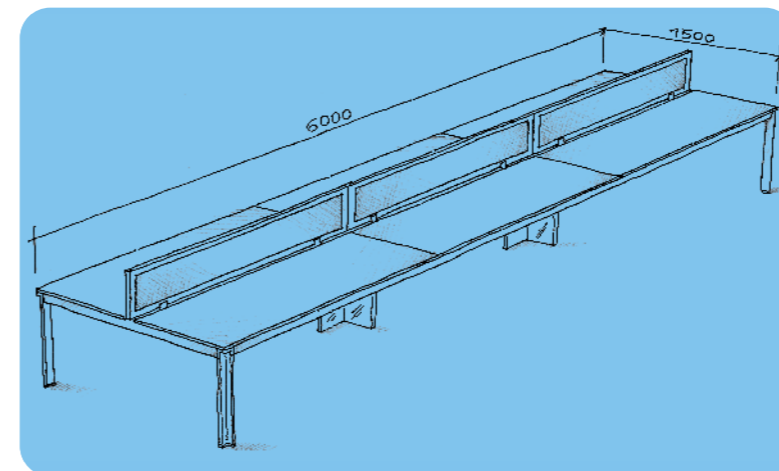

frames

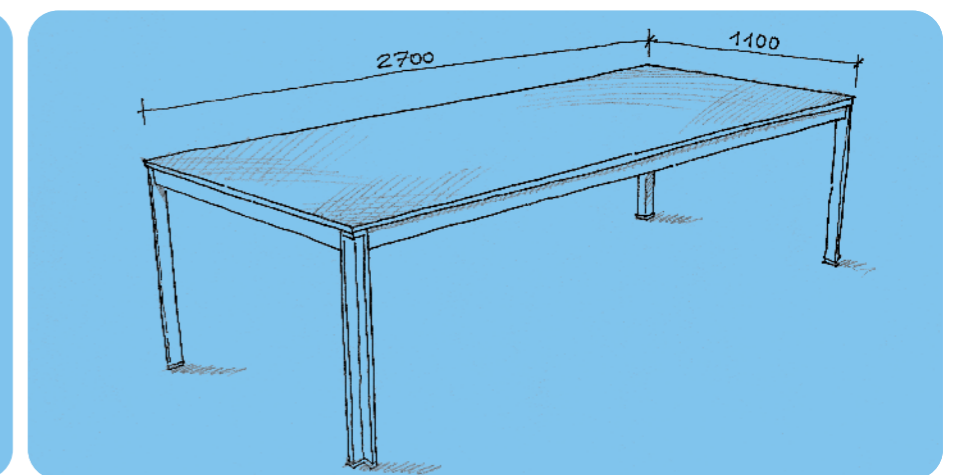



wiring

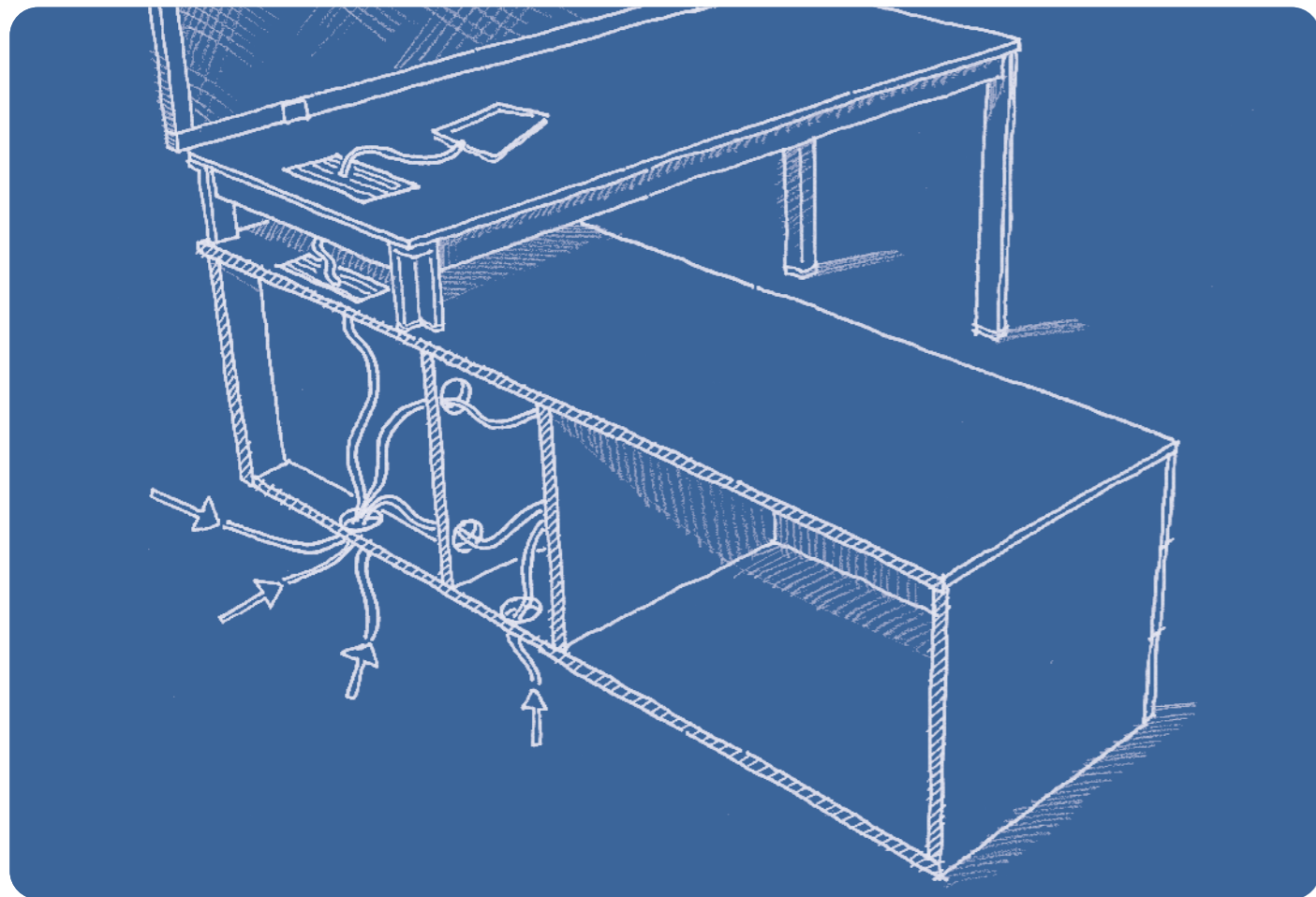



ZEFIRO è un classico che resiste nel tempo e si arricchisce ora di nuove soluzioni. Grazie alle caratteristiche tecniche peculiari e distintive quali il telaio perimetrale in alluminio anodizzato con un rapido sistema di aggancio tra gambe e traversi, la particolare sezione della gamba e la tecnologia del magnete per fissare il piano alla struttura, resta un prodotto unico e inimitabile.

ZEFIRO is an “evergreen” product now enhanced with new solutions. It stands as a unique and inimitable collection thanks to its distinguished technical features such as:

- the anodized aluminium frame with a quick linking system between legs and crossbars
- the leg special section
- the magnet technology to secure the top to the structure.

ZEFIRO est un classique qui résiste au temps et s’enrichit maintenant de nouvelles solutions. Grâce à ses caractéristiques techniques particulières et distinctives comme le cadre périmétral en aluminium anodisé avec son système de fixation rapide, la section particulière du piètement et la technologie de l’aimant pour fixer le plan de travail à la structure, Zefiro reste un produit unique et inimitable.

ZEFIRO es un producto “clásico” ahora mejorado con nuevas soluciones. Se distingue como colección única e inimitable gracias a sus características técnicas distinguidos tales como:

- el marco de aluminio anodizado con un sistema de enlace rápido entre las patas y los travesaños
- la sección especial de la pierna
- la tecnología de imanes para fijar la parte superior a la estructura.





Il telaio in alluminio anodizzato si può facilmente adattare nelle dimensioni, senza limitazioni di modulo. Nella soluzione con paretina portante agganciata a muro, i giunti tra gamba e telaio diventano elementi strutturali e permettono di limitare il numero di gambe. Alla paretina, attrezzabile con pannelli in tessuto puntaspilli, possono essere agganciati pensili con ante scorrevoli in metacrilato, mensole in cristallo o contenitori a giorno.

The anodized aluminium frame can easily be adjusted in size, without limitations. In the solution with the supporting wall unit, the joints between leg and frame become structural elements and allow to minimize the number of legs. The wall unit can be accessorized with fabric tackable panels as well as overheads with sliding doors in acrylic, glass shelves or open storages.

Le cadre en aluminium anodisé s'adapte facilement à toutes les exigences dimensionnelles, sans limitation de module. Dans la solution avec cloison porteuse accrochée au mur, les connecteurs à 3 voies, entre piétement et cadre, sont des éléments structuraux permettant de limiter le nombre des piétements. A la cloison qui peut être équipée de panneaux d'habillage en tissu punaisable on peut accrocher des rangements avec portes coulissantes en acrylique, tablettes en verre ou rangements ouverts.

El marco de aluminio anodizado se puede ajustar fácilmente en tamaño, sin limitaciones. En la solución con la unidad de pared de apoyo, las juntas entre la pierna y el marco se convierten en elementos estructurales y permiten reducir al mínimo el número de patas. La unidad de pared, disponible también con paneles tapizados en tela, se puede equipar con contenedores con puertas correderas en acrílico, o abiertos, y estantes de cristal.









ZEFIRO offre la possibilità di utilizzare contenitori dotati di vano porta CPU e cassetiera integrata come elemento di supporto laterale, sulla quale la scrivania poggia grazie a gambe ridotte in altezza. I contenitori, se collocati in sequenza come asse centrale, distribuiscono simmetricamente i posti lavoro. Cuscini rivestiti in tessuto possono essere applicati sul top.



ZEFIRO features side structural storages with CPU holder and pedestals. The desk top sits on the storage with legs reduced in height. The central storage spine can provide a symmetrical workplaces arrangement. Cushions covered in fabric can be applied on top.

ZEFIRO offre la possibilità d'utiliser des rangements équipés avec niche support u.c. et bloc tiroirs intégré, comme élément de support latéral sur lequel se pose le bureau, grâce à des piétements réduits en hauteur. Les rangements, positionnés en série comme axe central, permettent de distribuer symétriquement les postes de travail. Des coussins revêtus en tissu et fixés sur le top, transforment les rangements en une assise confortable pour les visiteurs.

ZEFIRO cuenta con almacenamientos laterales estructurales con soporte de CPU y pedestales. El escritorio se asienta en el almacenamiento con las piernas reducidas en altura. La columna vertebral de almacenamiento central puede proporcionar una disposición de los lugares de trabajo simétrico. Cojines tapizados en tela se pueden aplicar en la parte superior.



Il profilo in alluminio estruso di ZEFIRO ha grande leggerezza, resistenza e duttilità e può essere esteso a coprire grandi dimensioni con un forte impatto estetico. Nei bench di dimensioni superiori ai 270 cm di lunghezza viene utilizzato un supporto centrale in metacrilato trasparente per sostenere il telaio, dando l'impressione che il tavolo resti magicamente sospeso.

The extruded aluminium profiles of ZEFIRO frame have great lightness, strength and flexibility and can be extended to cover extra-long dimensions with a strong aesthetic impact. In the bench solutions, exceeding 270 cm in length (almost 9 feet) a central base in transparent acrylic holds the frame, giving the impression that the table is magically floating.

Le profil en aluminium extrudé de ZEFIRO est très léger, résistant et ductile: il permet de réaliser des tables de grandes dimensions avec un fort impact esthétique. Pour les benches de dimensions supérieures à 270cm de longueur, on utilise des bases en croix, en acrylique transparent pour supporter le cadre au milieu, donnant ainsi l'impression que la table est suspendue dans le vide.

Los perfiles de aluminio extruido del marco en ZEFIRO tienen gran ligereza, resistencia y flexibilidad y se pueden ampliar para cubrir las dimensiones extra-largos con un fuerte impacto estético. En las soluciones de bench, que exceden 270 cm de longitud (casi 9 pies), una base central en acrílico transparente mantiene el marco, dando la impresión de que la mesa está mágicamente flotando.





Gli screen di Zefiro sono dotati di profilo in alluminio anodizzato accessorabile con portacarte, portafiori e portapenne.

ZEFIRO screens with anodized aluminium frame, can be accessorised with papers, pens holder and flowers holders.

Les écrans de Zefiro sont équipés d'un rail en aluminium anodisé qui permet d'accrocher de bacs à feuilles, des porte-plumes et des porte-fleurs.

Las Pantallas en ZEFIRO cuentan con un marco de aluminio anodizado, se pueden tener accesorios tales como con bandejas portapapeles, porta bolígrafos y floreros.







Per le soluzioni direzionali il telaio in alluminio è disponibile anche nella opzione brill e si può abbinare a molteplici opzioni di finitura per il piano lavoro: da melaminici con nuove superfici materiche, ai legni impiallacciati ai vetri con trattamento anti-finger. Alla gamba possono essere applicati masselli riempitivi nelle diverse finiture.



For the executive private offices, the aluminium frame is available with a chromed-effect “brill” finish combined with a wide range of finishes for the desk tops: wooden melamine, wood veneer, anti-finger glass. Solid wood inserts can be added to the corner legs.

Pour les postes de direction, le cadre en aluminium est également disponible dans la finition polie brillante, et il peut être assorti avec toutes les options de finitions disponibles dédiées aux plans de travail: du mélaminé aux nouvelles finitions, comme le plaqué-bois, les plateaux en verre anti-taches rétro laqué. Les piétements peuvent aussi être équipés d’inserts en bois, disponibles dans les différentes finitions du catalogue.

Para las oficinas privadas de ejecutivos, la estructura de aluminio está disponible también en un efecto cromado y se puede combinar con una amplia gama de acabados para los escritorios de melamina: madera, chapa de madera, vidrio anti-dedo. Insertos de madera maciza se pueden añadir a las patas de esquinas.







Le prerogative tecniche e prestazionali, abbinata alla pulizia del design e alla flessibilità nelle dimensioni, fanno di ZEFIRO un prodotto che va oltre le mode del momento: un autentico classico dalle caratteristiche inimitabili, ma sorprendentemente attuale e adatto per ogni ambiente di lavoro, di lettura, di incontro.



Zefiro unique technical and performance features, combined with clean design and flexibility in size, make it a product that goes beyond the trend of the moment: a true classic with inimitable features, but surprisingly contemporary and suitable for any work environment, libraries, meeting areas.

Les performances et les caractéristiques techniques assorties d'un design propre et d'une grande flexibilité dans les dimensions, font de Zefiro un produit éternel: un classique authentique avec des prérogatives inimitables, mais qui reste étonnamment actuel, et adapté à chaque contexte de travail, de lecture, de rencontre.

Las Características técnicas y de funcionamiento únicas de Zefiro, combinadas con un diseño limpio y flexibilidad en el tamaño, lo convierten en un producto que va más allá de la tendencia del momento: un verdadero clásico con características inimitables, pero, sorprendentemente contemporáneos y adecuadas para cualquier ambiente de trabajo así como, áreas de reuniones y bibliotecas también.



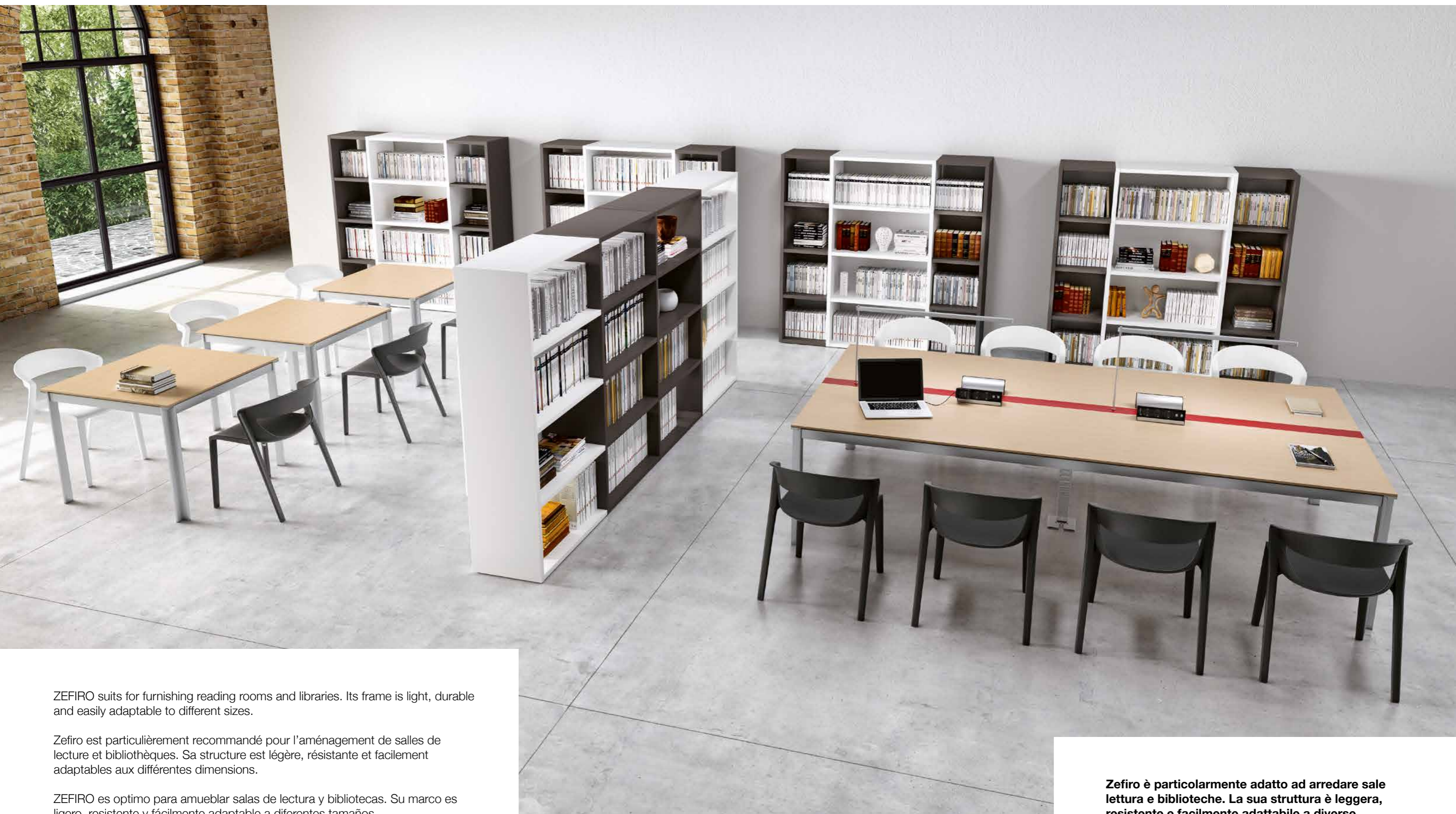

ZEFIRO suits for furnishing reading rooms and libraries. Its frame is light, durable and easily adaptable to different sizes.

Zefiro est particulièrement recommandé pour l'aménagement de salles de lecture et bibliothèques. Sa structure est légère, résistante et facilement adaptable aux différentes dimensions.







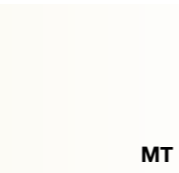

ZEFIRO es óptimo para amueblar salas de lectura y bibliotecas. Su marco es ligero, resistente y fácilmente adaptable a diferentes tamaños.

Zefiro è particolarmente adatto ad arredare sale lettura e biblioteche. La sua struttura è leggera, resistente e facilmente adattabile a diverse dimensioni.



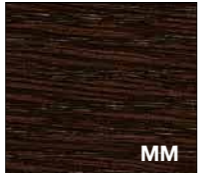

MEL

Melaminico Italian melamine Melaminé Melaminico

| | | | | | |
|---|---|---|---|--|---|
|  MB |  MG |  MF |  MZ |  MN |  MT |
| Bianco rigato Rippled effect white Blanc avec rayures Blanco rayado | Grigio rigato Rippled effect grey Gris avec rayures Gris rayado | Nichel Nickel Nickel Niquel | Cacao Cocoa Cacao Cacao | Bianco White Blanc Blanco | Talco Talco Talco Talco |
|  MJ |  MK |  MI |  MD |  ML |  MC |
| Ocra Ochre Ocre Ocre | Safari Safari Safari Safari | Noisette Noisette Noisette Noisette | Ardesia Ardesia Ardesia Pizarra | Nero Black Noir Negro | Rovere chiaro Light oak Chêne clair Roble claro |
|  MY |  ME |  MM |  MO |  MW | |
| Rovere americano American oak Chêne américain Roble americano | Rovere grigio Grey oak Chêne gris Roble gris | Rovere moro Dark oak Chêne foncé Roble oscuro | Noce Canaletto Canaletto Walnut Noyer Canaletto Nogal Canaletto | Noce scuro Dark walnut Noyer foncé Nogal oscuro | |
| Piano Top Plateau Sobre | Modesty panel Modesty panel Voile de fond Faldón | Inserto gamba Leg insert Insert pied Inserción para pata | Screen Screen Écran Panel | Contenitori Storages Rangements Armarios | Paretina boiserie Boiserie Wall unit Boiserie Panneau d'habillages Boiserie Paretina |

AL | BR





Metallo Metal Métal Metal

| | |
|--|--|
|  AL |  BR |
| Alluminio Aluminium Aluminium Aluminio | Brill Brill Brill Brill |

Struttura scrivania
Desk structure
Structure de bureau
Estructura de escritorio

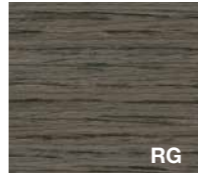
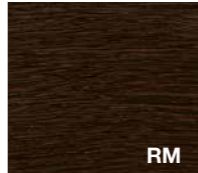

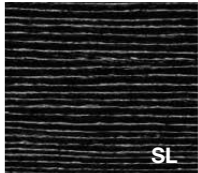







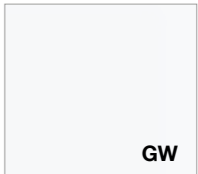

LGN

Legno Wood Bois Madera

| | | | | | |
|--|--|--|--|---|--|
|  RC |  RG |  RM |  NO |  SL |  EM |
| Rovere chiaro Light oak Chêne clair Roble claro | Rovere grigio fumo Smoke grey oak Chêne gris de fumée Roble gris humo | Rovere moro Dark oak Chêne foncé Roble oscuro | Noce Canaletto Canaletto walnut Noyer Canaletto Nogal Canaletto | Ebano silver Silver ebony Ebony silver Ebano plata | Ebano Makassar Makassar ebony Ebony Makassar Ebano Makassar |
|  NT | | | | | |
| Noce termocotto Heat-treated walnut Noyer thermo traité Nogal termotratado | | | | | |
| Piano Top Plateau Sobre | Modesty panel Modesty panel Voile de fond Faldón | Inserto gamba Leg insert Insert pied Inserción para pata | Contenitori Storages Rangements Armarios | Paretina boiserie Boiserie Wall unit Boiserie Panneau d'habillages Boiserie Paretina | |

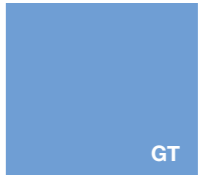
GOF

Goffrato Embossed Gaufré Gofrado

| | | | | | |
|--|--|--|---|--|--|
|  GF |  GD |  GO |  GR |  GZ |  GW |
| Goffrato Moka Embossed Mocha Gaufré Moka Gofrado Cafe | Goffrato Indaco Embossed Indigo Gaufré Indigo Gofrado Azul Indigo | Goffrato Rubino Embossed Ruby Gaufré Rubis Gofrado Rubi | Goffrato Cedro Embossed lime green Gaufré vert Cédrat Gofrado verde Cedro | Goffrato Argento Embossed Silver Gaufré Argent Gofrado Plata | Goffrato bianco Embossed white Gaufré blanc Gofrado blanco |
|  GY |  GQ |  GX |  GK |  GT |  GU |
| Goffrato nero Embossed black Gaufré noir Lacado negro | Goffrato rosso "F" Embossed red "F" Gaufré rouge "F" Lacado rojo "F" | Goffrato arancione Embossed orange Gaufré indigo Lacado naranja | Goffrato grigio scuro Embossed grey Gaufré gris Lacado gris | Goffrato azzurro Embossed blue Gaufré bleu Lacado azul | Goffrato verde Embossed green Gaufré vert Lacado verde |
|  GA |  GN | | | | |
| Ardesia Ardesia Ardesia Pizarra | Noisette Noisette Noisette Noisette | | | | |
| Modesty panel Modesty panel Voile de fond Faldón | Inserto gamba Leg insert Insert pied Inserción para pata | Contenitori Storages Rangements Armarios | Paretina boiserie Boiserie Wall unit Boiserie Panneau d'habillages Boiserie Paretina | | |

MTC

Metacrilato Metacrylate Méthacrylate Metacrilato

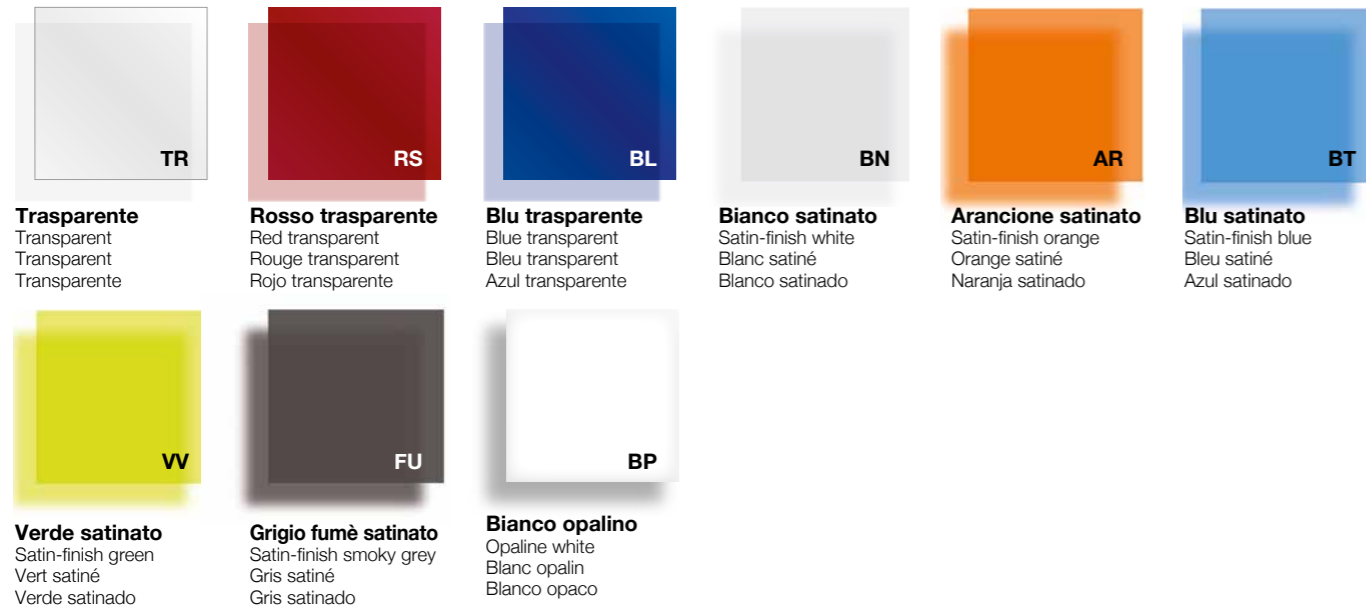

Screen
Screen
Écran
Panel

Paretina boiserie
Boiserie Wall unit
Boiserie Panneau
d'habillages
Boiserie Paretina

TES

Tessuto Fabric Tissu Tejido

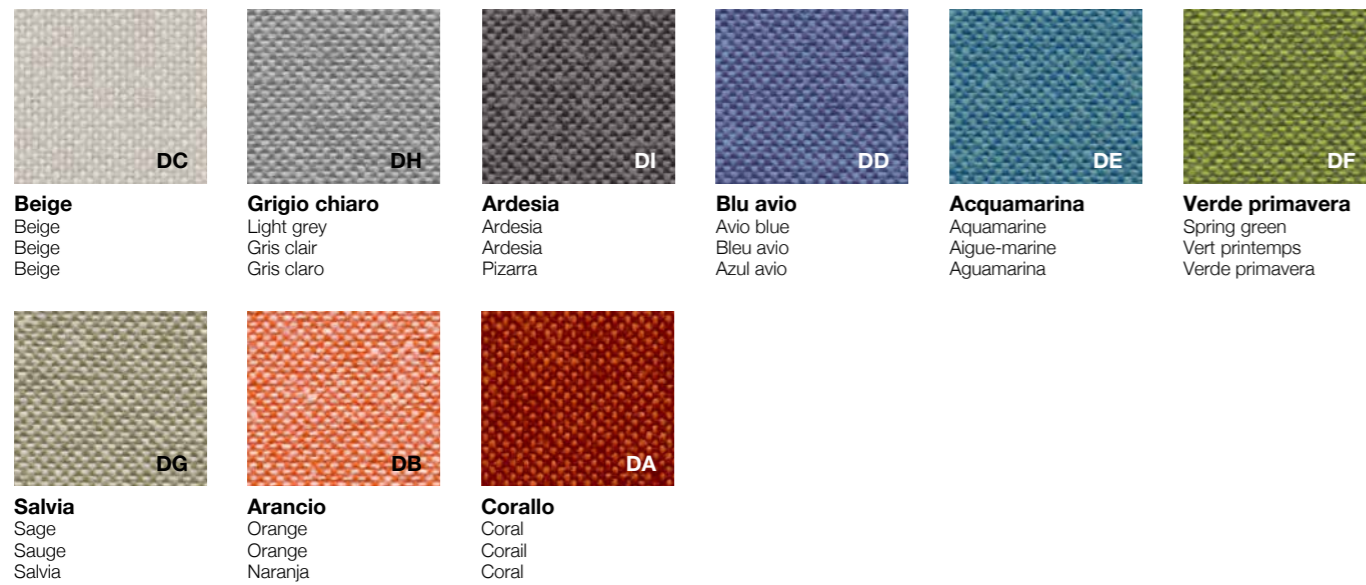

Screen
Screen
Écran
Panel

Paretina boiserie
Boiserie Wall unit
Boiserie Panneau
d'habillages
Boiserie Paretina

VTR

Vetro Glass Verre Vidrio

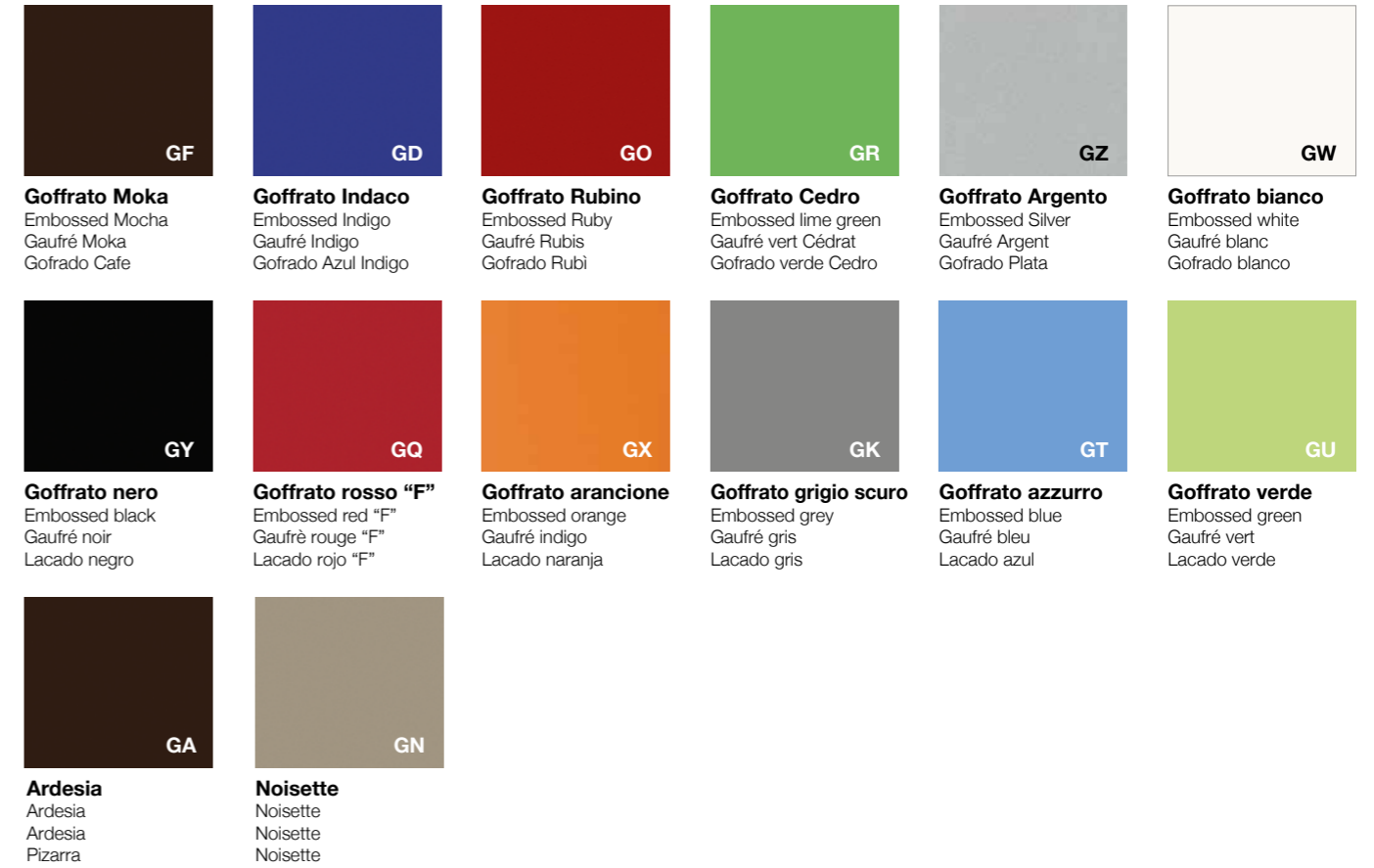

Piano
Top
Plateau
Sobre

ecologia

Alea utilizza per i suoi prodotti e i suoi imballi materiali facilmente separabili e riciclabili.

attestazione di prodotto

I prodotti Alea sono stati sottoposti a prove prestazionali presso laboratori di prova accreditati. Copia dei rapporti di prova o delle attestazioni di conformità sono disponibili su richiesta. I prodotti Alea soddisfano i requisiti LEED per il credito IEQ4.5 per i materiali a bassa emissione ed i requisiti ANSI/BIFMA X7.1-2011. Alea dichiara di utilizzare pannelli a base di legno aventi un rilascio di formaldeide conforme alla classe E1 secondo il DM 10/10/2008. Alea si impegna inoltre ad utilizzare materiali legnosi FSC e pannelli a base di legno con certificazione CARB2.

environment

Alea products and packaging are made of recyclable materials.

product certification

Alea products have been subjected to performance tests at accredited testing laboratories. Copies of test reports or certificates of conformity are available on request. Alea products meet the LEED requirements for IEQ4.5 credit for low emission materials and the ANSI/BIFMA X7.1-2011 requirements. Alea declares to use wood-based panels with a formaldehyde release according to class E1 according to DM 10/10/2008. Alea also undertakes to use FSC wood-based materials and CARB2-certified wood-based panels.

environnement

Alea utilise des matériaux facilement séparables et recyclables pour ses produits et ses emballages.

certification de produits

Les produits Alea ont été soumis à des tests de performance dans des laboratoires accrédités. Des copies des rapports d'essais ou des certificats de conformité sont disponibles sur demande. Les produits Alea répondent aux exigences LEED pour le crédit IEQ4.5 pour les matériaux à faibles émissions et aux exigences ANSI/BIFMA X7.1-2011. Alea déclare utiliser des panneaux à base de bois avec un dégagement de formaldéhyde selon la classe E1 selon DM 10/10/2008. Alea s'engage également à utiliser des matériaux à base de bois FSC et des panneaux à base de bois certifiés CARB2.

ecología

Alea utiliza productos y embalajes en materiales fácilmente separables y reciclables.

certificación de producto

Los productos Alea han sido sometidos a pruebas de rendimiento en laboratorios de pruebas acreditados. Copias de los informes de las pruebas o certificados de conformidad están disponibles bajo petición. Los productos Alea cumplen con los requisitos LEED para el crédito IEQ4.5 para materiales de baja emisión y los requisitos ANSI/BIFMA X7.1-2011. Alea declara utilizar paneles de madera con una emisión de formaldehído según la clase E1 según DM 10/10/2008. Alea también se compromete a utilizar materiales a base de madera FSC y paneles a base de madera certificados por CARB2.

concept & graphic design
Alea marketing + communication

design
Filippon & Mirto Antonel

art direction
Mirto Antonel

AF/CACB/AB

alea
aleaoffice.com



GLOBAL HEADQUARTERS AND SHOWROOM : Via Col de Rust, 19 - 33070 Sarone (PN) - Italia : Tel ++39 0434 777 333
email: info@aleaoffice.com **PARIS SHOWROOM** : 176 Avenue Charles de Gaulle 92200, Neuilly-sur-Seine - France **NORTH AMERICAN**
HEADQUARTERS : Midtown 2, 3449 NE 1st Avenue L-32, Miami, FL 33137 - USA : Tel ++1 305 470 1200 - email: info@alea-usa.com
ALEA UK OFFICE AND SHOWROOM : 50-54 Clerkenwell Road, London EC1M 5PS - email: info@aleaoffice.com