

# **ELEPHANT**

## **Components**

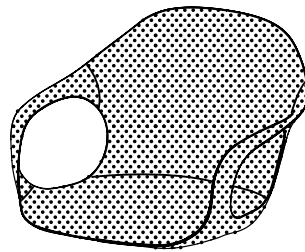
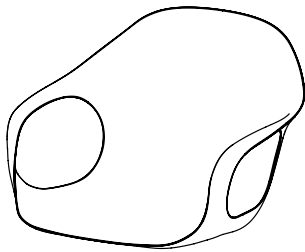
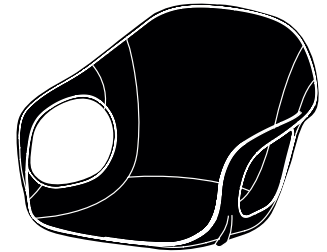
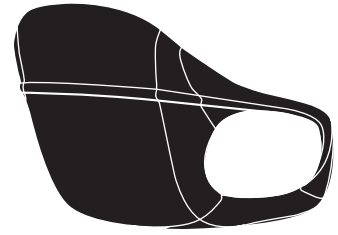

**Polyurethane seat**

**Fabric-upholstered seat**

**Hide-upholstered seat**



**Four legs**

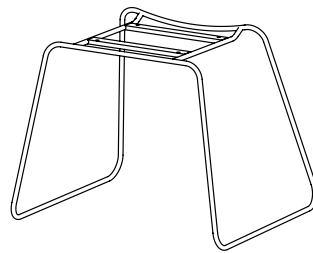

**Slide frame**

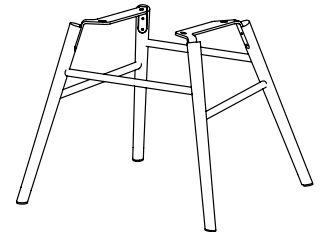

**Wooden base**

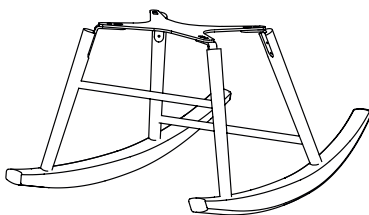

**Rocking**

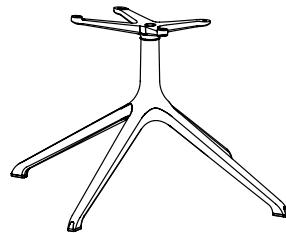

**Swivel trestle**

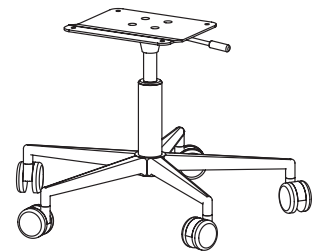

**5-spoke base**

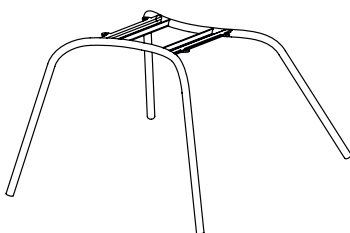

**Lounge**

# ELEPHANT

## Four legs - Polyurethane seat

### Base finish:

Polished chrome steel  
 Black chrome steel  
 Satin chrome steel  
 Brass-effect steel  
 Lacquered steel (in the same colour as the polyurethane)

### Body finish:

White polyurethane (P001)  
 Black polyurethane (P003)  
 Beige polyurethane (P004)  
 Terracotta brown polyurethane (P006)  
 Olive green polyurethane (P008)  
 Ruby red polyurethane (P010)  
 London grey polyurethane (P011)  
 Dust blue polyurethane (P012)

### Elephant cushion cover finish:

A = Valencia (synthetic leather), COM (Customer fabric)  
 B = Field 2  
 C = Clara 2, Merit  
 D = Curmi, Patio, Remix 2  
 E = Canvas 2, Hero, Melange Nap  
 F = Regal, Scuba, Steelcut Trio 3  
 G = Divina Melange 3, Hallingdal 65  
 H = Twill Weave

### Lips cushion cover finish:

A = COM (Customer fabric)  
 B = Field 2

### Note:

For COM orders see inside cover.

For info on fabric composition, see inside cover.

### FEET:

Standard in hard plastic. On request we supply feet with felt insert for wooden floors.

### SHIPPING INFO PRODUCTS DISASSEMBLED:

For orders of more than 8 units, chairs will be shipped knocked down (only armchairs with polyurethane seat).

- 4 seats = 1 pack - Kg 19 / m<sup>3</sup> 0,41.

- 4 bases = 1 pack - Kg 14 / m<sup>3</sup> 0,26.

Elephant cushion consumption: 0,55 ml (H. 140 cm).

Lips cushion consumption: 0,5 ml (H. 140 cm).

Reinforced packaging, see inside cover.

Code	Base	Body		
		pack	m <sup>3</sup>	Kg
		Polyurethane		
05ELE11	Lacquered steel, Polished chrome steel, Black chrome steel	1	0,4	10
	Brass-effect steel, Satin steel			

1 armchair in each package

### Optionals

Code	Description	Cover											pack	m <sup>3</sup>	Kg			
		A	B	C	D	E	F	G	H	L1	L2	L3						
20ELE01	Elephant removable cushion (not removable cover)												-	-	-	1	0,02	1
20LIR01	LIPS-R removable cushion (not removable cover)			-	-	-	-	-	-	-	-	-	-	-	-	1	0,01	1
20LIS01	LIPS-S removable cushion (not removable cover)			-	-	-	-	-	-	-	-	-	-	-	-	1	0,01	1
02PIE03	Set of felt feet															-	-	-

ELEPHANT (20ELE01)

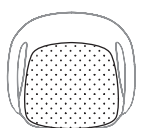

kg  
0,6

LIPS-R (20LIR01)

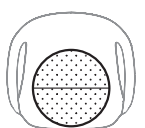

kg  
0,6

LIPS-S (20LIS01)



kg  
0,6

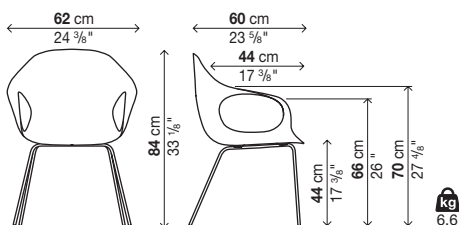

# ELEPHANT

## Four legs - Hide upholstered seat (not removable)

### Base finish:

Polished chrome steel  
 Black chrome steel  
 Satin chrome steel  
 Brass-effect steel  
 Lacquered steel (in the same colour as the polyurethane)

### Finish of cover:

"Cuoietto" (C) hide  
 Natural or black full grain hide (PF)

### Note:

Important: sizes and finishes marked with (!) require longer production lead time, about 6 weeks from the date of the order.

For stitching and edge colours refer to "colour chart" on inside cover.

### FEET:

Standard in hard plastic. On request we supply feet with felt insert for wooden floors.

Reinforced packaging, see inside cover.

Code	Base	Body		pack	m <sup>3</sup>	Kg
		Cuoietto (C) hide (!)	"Full-grain" hide (PF) (!)			
05ELE01	Lacquered steel, Polished chrome steel, Black chrome steel			1	0,4	11,5
	Brass-effect steel, Satin steel					

1 armchair in each package

### Optionals

Code	Description	pack	m <sup>3</sup>	Kg
02PIE03	Set of felt feet	-	-	-

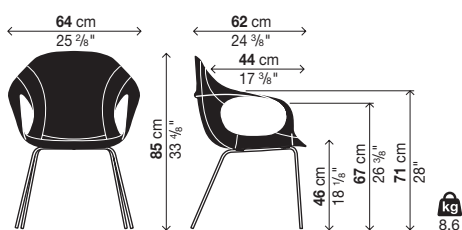

# ELEPHANT

## Four legs - Fabric upholstered seat (not removable)

### Base finish:

Polished chrome steel  
 Black chrome steel  
 Satin chrome steel  
 Brass-effect steel  
 Lacquered steel (in the same colours as the polyurethane)

### Finish of cover:

B = COM (Customer fabric)  
 D = Remix 2  
 E = Canvas 2, Hero, Melange Nap  
 F = Regal, Steelcut Trio 3  
 G = Divina Melange 3, Hallingdal 65  
 H = Twill Weave

### Note:

For COM orders see inside cover.

For info on fabric composition, see inside cover.

### FEET:

Standard in hard plastic. On request we supply feet with felt insert for wooden floors.

COM consumption: 1,5 ml (H. 140 cm).

Reinforced packaging, see inside cover.

Code	Base	Cover											pack	m <sup>2</sup>	Kg	
		A	B	C	D	E	F	G	H	L1	L2	L3				
05ELE51	Lacquered steel, Polished chrome steel, Black chrome steel	-		-							-	-	-	1	0,4	11
	Brass-effect steel, Satin steel	-		-							-	-	-			

1 armchair in each package

### Optionals

Code	Description	pack	m <sup>2</sup>	Kg
02PIE03	Set of felt feet	-	-	-

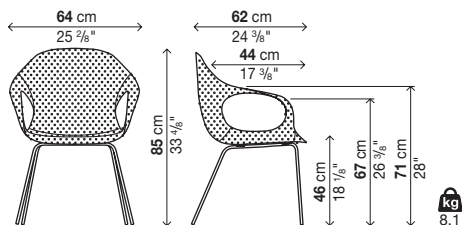

# ELEPHANT

## Slide frame - Polyurethane seat

### Base finish:

Polished chrome steel  
 Black chrome steel  
 Satin chrome steel  
 Brass-effect steel  
 Lacquered steel (in the same colour as the polyurethane)

### Body finish:

White polyurethane (P001)  
 Black polyurethane (P003)  
 Beige polyurethane (P004)  
 Terracotta brown polyurethane (P006)  
 Olive green polyurethane (P008)  
 Ruby red polyurethane (P010)  
 London grey polyurethane (P011)  
 Dust blue polyurethane (P012)

### Elephant cushion cover finish:

A = Valencia (synthetic leather), COM (Customer fabric)  
 B = Field 2  
 C = Clara 2, Merit  
 D = Curmi, Patio, Remix 2  
 E = Canvas 2, Hero, Melange Nap  
 F = Regal, Scuba, Steelcut Trio 3  
 G = Divina Melange 3, Hallingdal 65  
 H = Twill Weave

### Lips cushion cover finish:

A = COM (Customer fabric)  
 B = Field 2

### Note:

For COM orders see inside cover.

For info on fabric composition, see inside cover.

### FEET:

Standard in hard plastic. On request we supply feet with felt insert for wooden floors.

### SHIPPING INFO PRODUCTS DISASSEMBLED:

For orders of more than 8 units, chairs will be shipped knocked down (only armchairs with polyurethane seat).

- 4 seats = 1 pack - Kg 19 / m<sup>3</sup> 0,41  
 - 4 bases = 1 pack - Kg 19 / m<sup>3</sup> 0,26

Elephant cushion consumption: 0,55 ml (H. 140 cm).

Lips cushion consumption: 0,5 ml (H. 140 cm).

Reinforced packaging, see inside cover.

Code	Base	Body	
			pack m <sup>3</sup> Kg
		Polyurethane	
05ELE12	Lacquered steel, Polished chrome steel, Black chrome steel		1 0,4 11,2
	Brass-effect steel, Satin steel		

1 armchair in each package

### Optionals

Code	Description	Cover										pack m <sup>3</sup> Kg		
		A	B	C	D	E	F	G	H	L1	L2		L3	
20ELE01	Elephant removable cushion (not removable cover)										-	-	-	1 0,02 1
20LIR01	LIPS-R removable cushion (not removable cover)			-	-	-	-	-	-	-	-	-	-	1 0,01 1
20LIS01	LIPS-S removable cushion (not removable cover)			-	-	-	-	-	-	-	-	-	-	1 0,01 1
02PIE03	Set of felt feet													- - -

ELEPHANT (20ELE01)

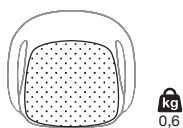

LIPS-R (20LIR01)

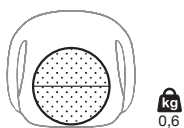

LIPS-S (20LIS01)

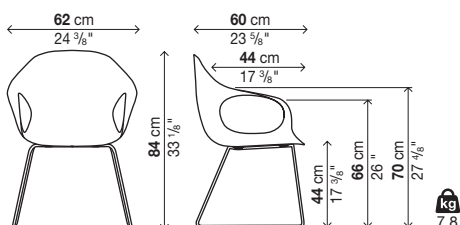
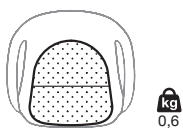

# ELEPHANT

## Slide frame - Hide upholstered seat (not removable)

### Base finish:

- Polished chrome steel
- Black chrome steel
- Satin chrome steel
- Brass-effect steel
- Lacquered steel (in the same colour as the polyurethane)

### Finish of cover:

- "Cuoietto" (C) hide
- Natural or black full grain hide (PF)

### Note:

Important: sizes and finishes marked with (!) require longer production lead time, about 6 weeks from the date of the order.

For stitching and edge colours refer to "colour chart" on inside cover.

### FEET:

Standard in hard plastic. On request we supply feet with felt insert for wooden floors.

Reinforced packaging, see inside cover.

Code	Base	Body		pack	m <sup>3</sup>	Kg
		Cuoietto (C) hide (!)	"Full-grain" hide (PF) (!)			
05ELE02	Lacquered steel, Polished chrome steel, Black chrome steel			1	0,4	13
	Brass-effect steel, Satin steel					

1 armchair in each package

### Optionals

Code	Description	pack	m <sup>3</sup>	Kg
02PIE03	Set of felt feet	-	-	-

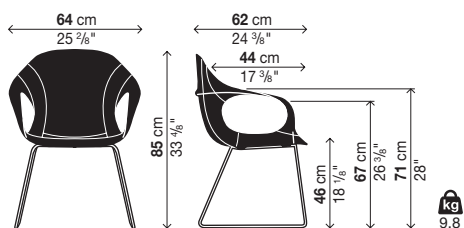

# ELEPHANT

## Slide frame - Fabric upholstered seat (not removable)

### Base finish:

- Polished chrome steel
- Black chrome steel
- Satin chrome steel
- Brass-effect steel
- Lacquered steel (in the same colours as the polyurethane)

### Finish of cover:

- B = COM (Customer fabric)
- D = Remix 2
- E = Canvas 2, Hero, Melange Nap
- F = Regal, Steelcut Trio 3
- G = Divina Melange 3, Hallingdal 65
- H = Twill Weave

### Note:

For COM orders see inside cover.

For info on fabric composition, see inside cover.

### FEET:

Standard in hard plastic. On request we supply feet with felt insert for wooden floors.

COM consumption: 1,5 ml (H. 140 cm).

Reinforced packaging, see inside cover.

Code	Base	Cover										pack	m <sup>2</sup>	Kg		
		A	B	C	D	E	F	G	H	L1	L2				L3	
05ELE52	Lacquered steel, Polished chrome steel, Black chrome steel	-		-							-	-	-	1	0,4	12,5
	Brass-effect steel, Satin steel	-		-							-	-	-			

1 armchair in each package

### Optionals

Code	Description	pack	m <sup>2</sup>	Kg
02PIE04	Set of felt feet	-	-	-

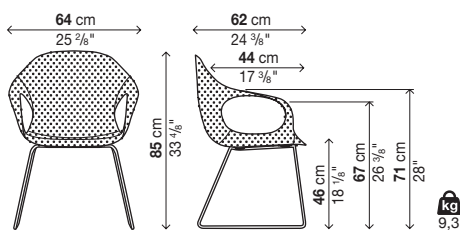

# ELEPHANT

## Wooden base - Polyurethane seat

### Base finish:

Solid beech  
Solid european oak  
Walnut stained solid oak  
Lacquered solid wood (in the same colours as the polyurethane)

### Body finish:

White polyurethane (P001)  
Black polyurethane (P003)  
Beige polyurethane (P004)  
Terracotta brown polyurethane (P006)  
Olive green polyurethane (P008)  
Ruby red polyurethane (P010)  
London grey polyurethane (P011)  
Dust blue polyurethane (P012)

### Elephant cushion cover finish:

A = Valencia (synthetic leather), COM (Customer fabric)  
B = Field 2  
C = Clara 2, Merit  
D = Curmi, Patio, Remix 2  
E = Canvas 2, Hero, Melange Nap  
F = Regal, Scuba, Steelcut Trio 3  
G = Divina Melange 3, Hallingdal 65  
H = Twill Weave

### Lips cushion cover finish:

A = COM (Customer fabric)  
B = Field 2

### Note:

For COM orders see inside cover.

For info on fabric composition, see inside cover.

### FEET:

Standard in hard plastic. On request we supply feet with felt insert for wooden floors.

### SHIPPING INFO PRODUCTS DISASSEMBLED:

For orders of more than 8 units, chairs will be shipped knocked down (only armchairs with polyurethane seat).

- 4 seats = 1 pack - Kg 19 / m<sup>3</sup> 0,41

- 4 bases = 1 pack - Kg 12 / m<sup>3</sup> 0,33

Elephant cushion consumption: 0,55 ml (H. 140 cm).

Lips cushion consumption: 0,5 ml (H. 140 cm).

Reinforced packaging, see inside cover.

Code	Base	Body		
		pack	m <sup>3</sup>	Kg
		Polyurethane		
05ELE82	Beech			
	European oak, Walnut stained oak, Lacquered wood	1	0,4	9,3

1 armchair in each package

### Optionals

Code	Description	Cover											pack	m <sup>3</sup>	Kg	
		A	B	C	D	E	F	G	H	L1	L2	L3				
20ELE01	Elephant removable cushion (not removable cover)										-	-	-	1	0,02	1
20LIR01	LIPS-R removable cushion (not removable cover)			-	-	-	-	-	-	-	-	-	-	1	0,01	1
20LIS01	LIPS-S removable cushion (not removable cover)			-	-	-	-	-	-	-	-	-	-	1	0,01	1
02PIE05	Set of felt feet															

ELEPHANT (20ELE01)

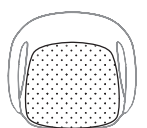

LIPS-R (20LIR01)

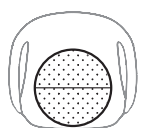

LIPS-S (20LIS01)

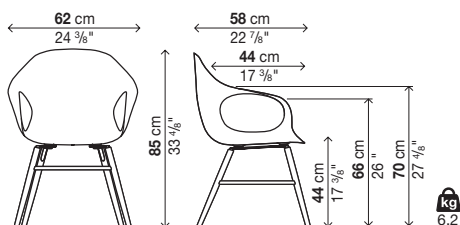
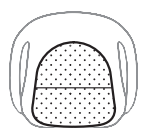



# ELEPHANT

## Wooden base - Hide upholstered seat (not removable)

### Base finish:

Solid beech  
 Solid european oak  
 Walnut stained solid oak  
 Lacquered solid wood (in the same colours as the polyurethane)

### Finish of cover:

"Cuoietto" (C) hide  
 Natural or black full grain hide (PF)

### Note:

Important: sizes and finishes marked with (!) require longer production lead time, about 6 weeks from the date of the order.

For stitching and edge colours refer to "colour chart" on inside cover.

### FEET:

Standard in hard plastic. On request we supply feet with felt insert for wooden floors.

Reinforced packaging, see inside cover.

Code	Base	Body		pack	m³	Kg
		Cuoietto (C) hide (!)	"Full-grain" hide (PF) (!)			
<b>05ELE81</b>	Beech			1	0,38	11,2
	European oak, Walnut stained oak, Lacquered wood					

1 armchair in each package

### Optionals

Code	Description	pack	m³	Kg
<b>02PIE05</b>	Set of felt feet	-	-	-

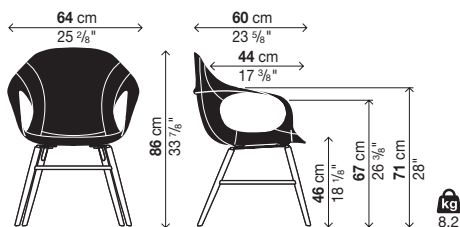

# ELEPHANT

## Wooden base - Fabric upholstered seat (not removable)

### Base finish:

Solid beech  
 Solid european oak  
 Walnut stained solid oak  
 Lacquered solid wood (in the same colours as the polyurethane)

### Finish of cover:

B = COM (Customer fabric)  
 D = Remix 2  
 E = Canvas 2, Hero, Melange Nap  
 F = Regal, Steelcut Trio 3  
 G = Divina Melange 3, Hallingdal 65  
 H = Twill Weave

### Note:

For COM orders see inside cover.

For info on fabric composition, see inside cover.

### FEET:

Standard in hard plastic. On request we supply feet with felt insert for wooden floors.

COM consumption: 1,5 ml (H. 140 cm).

Reinforced packaging, see inside cover.

Code	Base	Cover											pack	m <sup>3</sup>	Kg	
		A	B	C	D	E	F	G	H	L1	L2	L3				
05ELE53	Beech	-		-							-	-	-	1	0,4	10,7
	European oak, Walnut stained oak, Lacquered wood	-		-							-	-	-			

1 armchair in each package

### Optionals

Code	Description	pack	m <sup>3</sup>	Kg
02PIE05	Set of felt feet	-	-	-

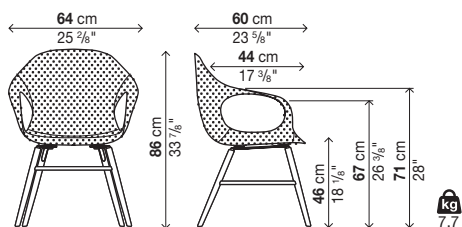

# ELEPHANT

## Rocking - Polyurethane seat

### Base finish:

Solid beech  
Solid european oak  
Walnut stained solid oak  
Lacquered solid wood (in the same colours as the polyurethane)

### Body finish:

White polyurethane (P001)  
Black polyurethane (P003)  
Beige polyurethane (P004)  
Terracotta brown polyurethane (P006)  
Olive green polyurethane (P008)  
Ruby red polyurethane (P010)  
London grey polyurethane (P011)  
Dust blue polyurethane (P012)

### Elephant cushion cover finish:

A = Valencia (synthetic leather), COM (Customer fabric)  
B = Field 2  
C = Clara 2, Merit  
D = Curmi, Patio, Remix 2  
E = Canvas 2, Hero, Melange Nap  
F = Regal, Scuba, Steelcut Trio 3  
G = Divina Melange 3, Hallingdal 65  
H = Twill Weave

### Lips cushion cover finish:

A = COM (Customer fabric)  
B = Field 2

### Note:

For COM orders see inside cover.

For info on fabric composition, see inside cover.

### SHIPPING INFO PRODUCTS DISASSEMBLED:

For orders of more than 8 units, chairs will be shipped knocked down (only armchairs with polyurethane seat).  
- 4 seats = 1 pack - Kg 19 / m<sup>3</sup> 0,41  
- 2 bases = 1 pack - Kg 10 / m<sup>3</sup> 0,34

Elephant cushion consumption: 0,55 ml (H. 140 cm).

Lips cushion consumption: 0,5 ml (H. 140 cm).

Reinforced packaging, see inside cover.

Code	Base	Body	
			pack m <sup>3</sup> Kg
		Polyurethane	
05ELE91	Beech		
	European oak, Walnut stained oak, Lacquered wood		1 0,56 12

1 armchair in each package

### Optionals

Code	Description	Cover										pack m <sup>3</sup> Kg	
		A	B	C	D	E	F	G	H	L1	L2		L3
20ELE01	Elephant removable cushion (not removable cover)									-	-	-	1 0,02 1
20LIR01	LIPS-R removable cushion (not removable cover)			-	-	-	-	-	-	-	-	-	1 0,01 1
20LIS01	LIPS-S removable cushion (not removable cover)			-	-	-	-	-	-	-	-	-	1 0,01 1

ELEPHANT (20ELE01)

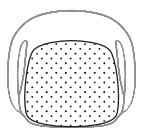

kg  
0,6

LIPS-R (20LIR01)

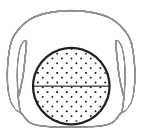

kg  
0,6

LIPS-S (20LIS01)

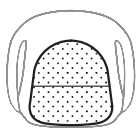

kg  
0,6

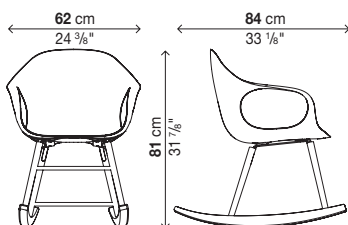

# ELEPHANT

## Rocking - Hide upholstered seat (not removable)

### Base finish:

Solid beech  
 Solid european oak  
 Walnut stained solid oak  
 Lacquered solid wood (in the same colours as the polyurethane)

### Finish of cover:

"Cuoietto" (C) hide  
 Natural or black full grain hide (PF)

### Note:

Important: sizes and finishes marked with (!) require longer production lead time, about 6 weeks from the date of the order.

For stitching and edge colours refer to "colour chart" on inside cover.

Reinforced packaging, see inside cover.

Code	Base	Body		pack	m <sup>3</sup>	Kg
		Cuoietto (C) hide (!)	"Full-grain" hide (PF) (!)			
05ELE92	Beech			1	0,56	14
	European oak, Walnut stained oak, Lacquered wood					

1 armchair in each package

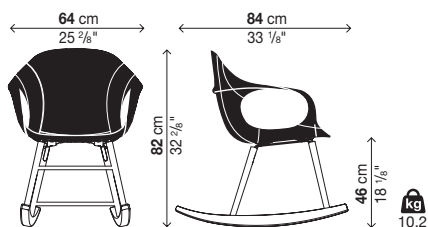

# ELEPHANT

## Rocking - Fabric upholstered seat (not removable)

### Base finish:

Solid beech  
 Solid european oak  
 Walnut stained solid oak  
 Lacquered solid wood (in the same colours as the polyurethane)

### Finish of cover:

B = COM (Customer fabric)  
 D = Remix 2  
 E = Canvas 2, Hero, Melange Nap  
 F = Regal, Steelcut Trio 3  
 G = Divina Melange 3, Hallingdal 65  
 H = Twill Weave

### Note:

For COM orders see inside cover.  
 For info on fabric composition, see inside cover.  
 COM consumption: 1,5 ml (H. 140 cm).  
 Reinforced packaging, see inside cover.

Code	Base	Cover										pack	m <sup>3</sup>	Kg	
		A	B	C	D	E	F	G	H	L1	L2				L3
<b>05ELE93</b>	Beech	-		-						-	-	-	1	0,56	13,5
	European oak, Walnut stained oak, Lacquered wood	-		-						-	-	-			

1 armchair in each package

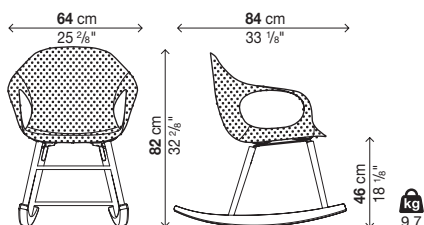

# ELEPHANT

## Swivel trestle - Polyurethane seat

### Base finish:

Polished aluminium

Lacquered aluminium (in the same colours as the polyurethane)

### Body finish:

White polyurethane (P001)

Black polyurethane (P003)

Beige polyurethane (P004)

Terracotta brown polyurethane (P006)

Olive green polyurethane (P008)

Ruby red polyurethane (P010)

London grey polyurethane (P011)

Dust blue polyurethane (P012)

### Elephant cushion cover finish:

A = Valencia (synthetic leather), COM (Customer fabric)

B = Field 2

C = Clara 2, Merit

D = Curmi, Patio, Remix 2

E = Canvas 2, Hero, Melange Nap

F = Regal, Scuba, Steelcut Trio 3

G = Divina Melange 3, Hallingdal 65

H = Twill Weave

### Lips cushion cover finish:

A = COM (Customer fabric)

B = Field 2

### Note:

For COM orders see inside cover.

For info on fabric composition, see inside cover.

### FEET:

Standard with felt insert for wooden floors.

### SHIPPING INFO PRODUCTS DISASSEMBLED:

For orders of more than 8 units, chairs will be shipped knocked down (only armchairs with polyurethane seat).

- 4 seats = 1 pack - Kg 19 / m<sup>3</sup> 0,41

- 1 bases = 1 pack - Kg 6 / m<sup>3</sup> 0,14

Elephant cushion consumption: 0,55 ml (H. 140 cm).

Lips cushion consumption: 0,5 ml (H. 140 cm).

Reinforced packaging, see inside cover.

Code	Base	Body		pack	m <sup>3</sup>	Kg
			Polyurethane			
05ELE72	Lacquered aluminium			1	0,38	11,5
	Polished aluminium					

1 armchair in each package

### Optionals

Code	Description	Cover											pack	m <sup>3</sup>	Kg			
		A	B	C	D	E	F	G	H	L1	L2	L3						
20ELE01	Elephant removable cushion (not removable cover)												-	-	-	1	0,02	1
20LIR01	LIPS-R removable cushion (not removable cover)			-	-	-	-	-	-	-	-	-	-	-	-	1	0,01	1
20LIS01	LIPS-S removable cushion (not removable cover)			-	-	-	-	-	-	-	-	-	-	-	-	1	0,01	1

ELEPHANT (20ELE01)



LIPS-R (20LIR01)

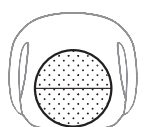

LIPS-S (20LIS01)

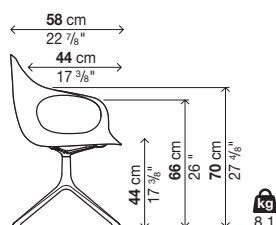
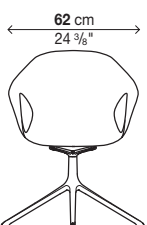
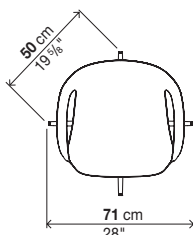
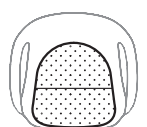

# ELEPHANT

## Swivel trestle - Hide upholstered seat (not removable)

### Base finish:

Polished aluminium  
Lacquered aluminium (in the same colours as the polyurethane)

### Finish of cover:

"Cuoietto" (C) hide  
Natural or black full grain hide (PF)

### Note:

Important: sizes and finishes marked with (!) require longer production lead time, about 6 weeks from the date of the order.

For stitching and edge colours refer to "colour chart" on inside cover.

### FEET:

Standard with felt insert for wooden floors.

Reinforced packaging, see inside cover.

Code	Base	Body		pack	m <sup>3</sup>	Kg
		Cuoietto (C) hide (!)	"Full-grain" hide (PF) (!)			
05ELE71	Lacquered aluminium			1	0,38	14
	Polished aluminium					

1 armchair in each package

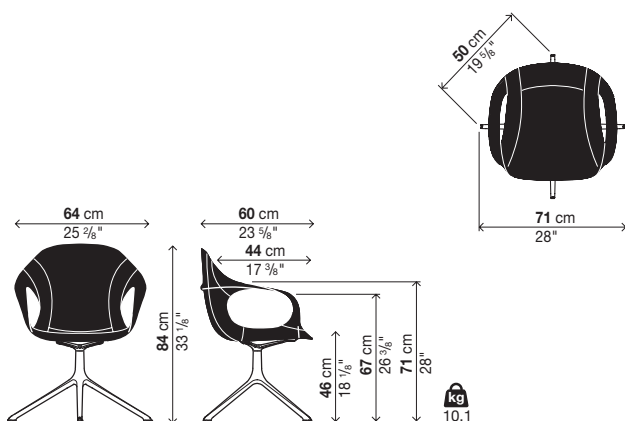

# ELEPHANT

## Swivel trestle - Fabric upholstered seat (not removable)

### Base finish:

Polished aluminium

Lacquered aluminium (in the same colours as the polyurethane)

### Finish of cover:

B = COM (Customer fabric)

D = Remix 2

E = Canvas 2, Hero, Melange Nap

F = Regal, Steelcut Trio 3

G = Divina Melange 3, Hallingdal 65

H = Twill Weave

### Note:

For COM orders see inside cover.

For info on fabric composition, see inside cover.

### FEET:

Standard with felt insert for wooden floors.

COM consumption: 1,5 ml (H. 140 cm).

Reinforced packaging, see inside cover.

Code	Base	Cover											pack	m <sup>2</sup>	Kg	
		A	B	C	D	E	F	G	H	L1	L2	L3				
05ELE54	Lacquered aluminium	-		-							-	-	-	1	0,38	13,5
	Polished aluminium	-		-							-	-	-			

1 armchair in each package

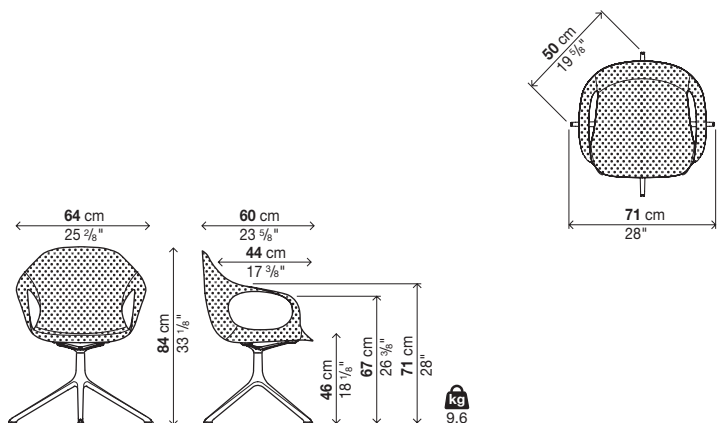



# ELEPHANT

## 5 spoke base with castors - Polyurethane seat

### Base finish:

Polished aluminium  
Lacquered aluminium (white, black)

### Body finish:

White polyurethane (P001)  
Black polyurethane (P003)  
Beige polyurethane (P004)  
Terracotta brown polyurethane (P006)  
Olive green polyurethane (P008)  
Ruby red polyurethane (P010)  
London grey polyurethane (P011)  
Dust blue polyurethane (P012)

### Elephant cushion cover finish:

A = Valencia (synthetic leather), COM (Customer fabric)  
B = Field 2  
C = Clara 2, Merit  
D = Curmi, Patio, Remix 2  
E = Canvas 2, Hero, Melange Nap  
F = Regal, Scuba, Steelcut Trio 3  
G = Divina Melange 3, Hallingdal 65  
H = Twill Weave

### Lips cushion cover finish:

A = COM (Customer fabric)  
B = Field 2

### Note:

For COM orders see inside cover.

For info on fabric composition, see inside cover.

Soft tread, self-locking swivel castors.

### SHIPPING INFO PRODUCTS DISASSEMBLED:

For orders of more than 8 units, chairs will be shipped knocked down (only armchairs with polyurethane seat).

- 4 seats = 1 pack - Kg 19 / m<sup>3</sup> 0,41  
- 1 bases = 1 pack - Kg 15 / m<sup>3</sup> 0,14

Elephant cushion consumption: 0,55 ml (H. 140 cm).

Lips cushion consumption: 0,5 ml (H. 140 cm).

Reinforced packaging, see inside cover.

Code	Base	Body		
		pack	m <sup>3</sup>	Kg
		Polyurethane		
05ELE41	Lacquered aluminium	1	0,38	13
	Polished aluminium			

1 armchair in each package

### Optionals

Code	Description	Cover										pack	m <sup>3</sup>	Kg			
		A	B	C	D	E	F	G	H	L1	L2				L3		
20ELE01	Elephant removable cushion (not removable cover)											-	-	-	1	0,02	1
20LIR01	LIPS-R removable cushion (not removable cover)			-	-	-	-	-	-	-	-	-	-	-	1	0,01	1
20LIS01	LIPS-S removable cushion (not removable cover)			-	-	-	-	-	-	-	-	-	-	-	1	0,01	1

ELEPHANT (20ELE01)

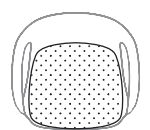

LIPS-R (20LIR01)

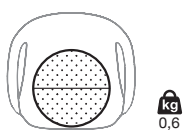

LIPS-S (20LIS01)

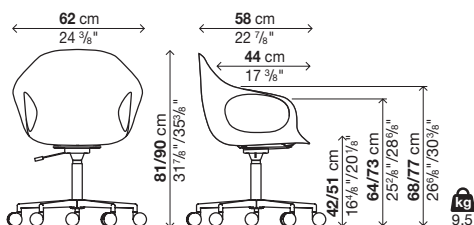
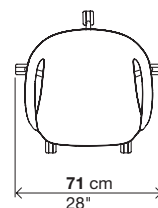
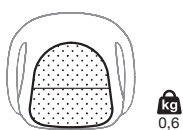

# ELEPHANT

## 5 spoke base with castors - Hide upholstered seat (not removable)

### Base finish:

Polished aluminium  
Lacquered aluminium (white, black)

### Finish of cover:

"Cuoietto" (C) hide  
Natural or black full grain hide (PF)

### Note:

Important: sizes and finishes marked with (!) require longer production lead time, about 6 weeks from the date of the order.

For stitching and edge colours refer to "colour chart" on inside cover.

Soft tread, self-locking swivel castors.

Reinforced packaging, see inside cover.

Code	Base	Body		pack	m <sup>3</sup>	Kg
		Cuoietto (C) hide (!)	"Full-grain" hide (PF) (!)			
<b>05ELE42</b>	Lacquered aluminium			1	0,38	15,5
	Polished aluminium					

1 armchair in each package

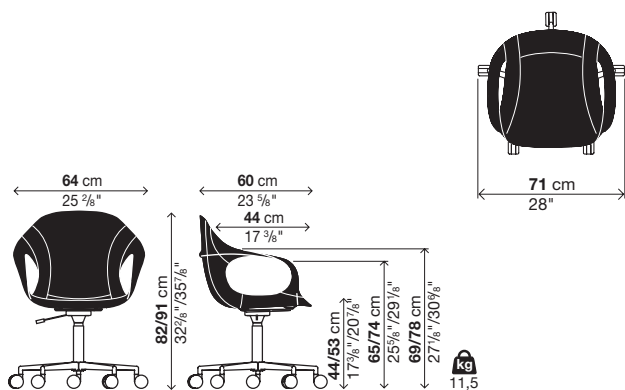

# ELEPHANT

## 5 spoke base with castors - Fabric upholstered seat (not removable)

### Base finish:

Polished aluminium  
Lacquered aluminium (white, black)

### Finish of cover:

B = COM (Customer fabric)  
D = Remix 2  
E = Canvas 2, Hero, Melange Nap  
F = Regal, Steelcut Trio  
G = Divina Melange 3, Hallingdal 65  
H = Twill Weave

### Note:

For COM orders see inside cover.

For info on fabric composition, see inside cover.

Soft tread, self-locking swivel castors.

COM consumption: 1,5 ml (H. 140 cm).

Reinforced packaging, see inside cover.

Code	Base	Cover											pack	m <sup>2</sup>	Kg	
		A	B	C	D	E	F	G	H	L1	L2	L3				
05ELE43	Lacquered aluminium	-		-							-	-	-	1	0,38	15
	Polished aluminium	-		-							-	-	-			

1 armchair in each package

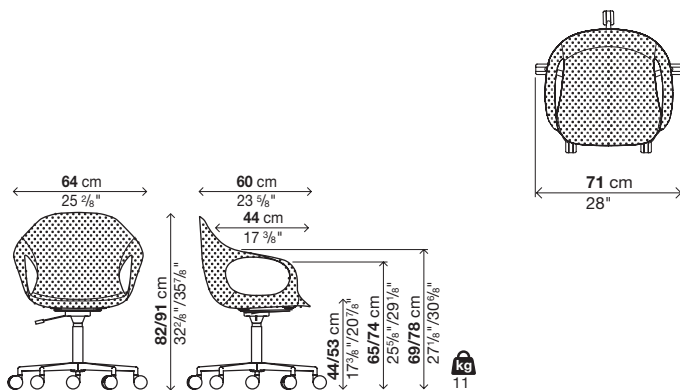

# ELEPHANT

## Armchair lounge - Polyurethane seat

### Base finish:

Polished chrome steel  
 Black chrome steel  
 Brass-effect steel  
 Lacquered steel (in the same colour as the polyurethane)

### Body finish:

White polyurethane (P001)  
 Black polyurethane (P003)  
 Beige polyurethane (P004)  
 Terracotta brown polyurethane (P006)  
 Olive green polyurethane (P008)  
 Ruby red polyurethane (P010)  
 London grey polyurethane (P011)  
 Dust blue polyurethane (P012)

### Elephant cushion cover finish:

A = Valencia (synthetic leather), COM (Customer fabric)  
 B = Field 2  
 C = Clara 2, Merit  
 D = Curmi, Patio, Remix 2  
 E = Canvas 2, Hero, Melange Nap  
 F = Regal, Scuba, Steelcut Trio 3  
 G = Divina Melange 3, Hallingdal 65  
 H = Twill Weave

### Lips cushion cover finish:

A = COM (Customer fabric)  
 B = Field 2

### Note:

For COM orders see inside cover.

For info on fabric composition, see inside cover.

### FEET:

Standard in hard plastic. On request we supply feet with felt insert for wooden floors.

### SHIPPING INFO PRODUCTS DISASSEMBLED:

For orders of more than 8 units, chairs will be shipped knocked down (only armchairs with polyurethane seat).

- 4 seats = 1 pack - Kg 19 / m<sup>3</sup> 0,41

- 4 bases = 1 pack - Kg 14 / m<sup>3</sup> 0,28

Elephant cushion consumption: 0,55 ml (H. 140 cm).

Lips cushion consumption: 0,5 ml (H. 140 cm).

Reinforced packaging, see inside cover.

Code	Base	Body		
		pack	m <sup>3</sup>	Kg
		Polyurethane		
05ELE03	Lacquered steel, Polished chrome steel, Black chrome steel	1	0,4	10
	Brass-effect steel			

1 armchair in each package

### Optionals

Code	Description	Cover											pack	m <sup>3</sup>	Kg	
		A	B	C	D	E	F	G	H	L1	L2	L3				
20ELE01	Elephant removable cushion (not removable cover)										-	-	-	1	0,02	1
20LIR01	LIPS-R removable cushion (not removable cover)			-	-	-	-	-	-	-	-	-	-	1	0,01	1
20LIS01	LIPS-S removable cushion (not removable cover)			-	-	-	-	-	-	-	-	-	-	1	0,01	1
02PIE14	Set of felt feet													-	-	-

ELEPHANT (20ELE01)

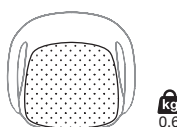

LIPS-R (20LIR01)



LIPS-S (20LIS01)

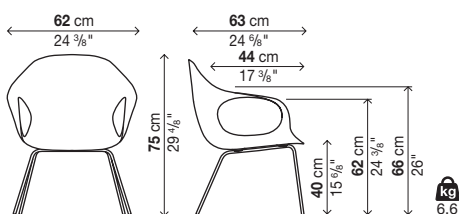
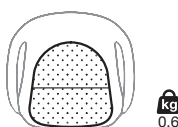

# ELEPHANT

## Armchair lounge - Hide upholstered seat (not removable)

### Base finish:

- Polished chrome steel
- Black chrome steel
- Brass-effect steel
- Lacquered steel (in the same colour as the polyurethane)

### Finish of cover:

- "Cuoietto" (C) hide
- Natural or black full grain hide (PF)

### Note:

Important: sizes and finishes marked with (!) require longer production lead time, about 6 weeks from the date of the order.

For stitching and edge colours refer to "colour chart" on inside cover.

Reinforced packaging, see inside cover.

Code	Base	Body		pack	m <sup>2</sup>	Kg
		Cuoietto (C) hide (!)	"Full-grain" hide (PF) (!)			
05ELE13	Lacquered steel, Polished chrome steel, Black chrome steel			1	0,4	11,5
	Brass-effect steel					

1 armchair in each package

### Optionals

Code	Description	pack	m <sup>2</sup>	Kg
02PIE14	Set of felt feet	-	-	-

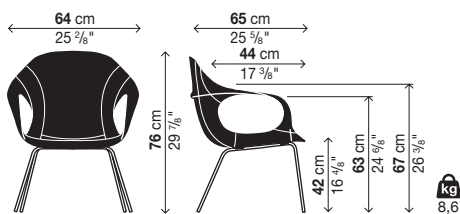

# ELEPHANT

## Armchair lounge - Fabric upholstered seat (not removable)

### Base finish:

Polished chrome steel  
 Black chrome steel  
 Brass-effect steel  
 Lacquered steel (in the same colours as the polyurethane)

### Finish of cover:

B = COM (Customer fabric)  
 D = Remix 2  
 E = Canvas 2, Hero, Melange Nap  
 F = Regal, Steelcut Trio 3  
 G = Divina Melange 3, Hallingdal 65  
 H = Twill Weave

### Note:

For COM orders see inside cover.

For info on fabric composition, see inside cover.

### FEET:

Standard in hard plastic. On request we supply feet with felt insert for wooden floors.

COM consumption: 1,5 ml (H. 140 cm).

Reinforced packaging, see inside cover.

Code	Base	Cover										pack	m <sup>3</sup>	Kg	
		A	B	C	D	E	F	G	H	L1	L2				L3
05ELE23	Lacquered steel, Polished chrome steel, Black chrome steel	-		-						-	-	-	1	0,4	11
	Brass-effect steel	-		-						-	-	-			

1 armchair in each package

### Optionals

Code	Description	pack	m <sup>3</sup>	Kg
02PIE14	Set of felt feet	-	-	-

