

ELEPHANT

Components

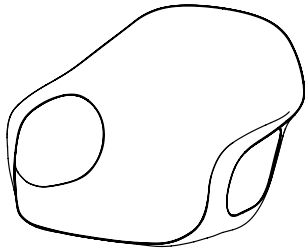

Polyurethane seat

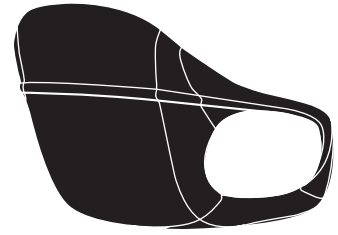
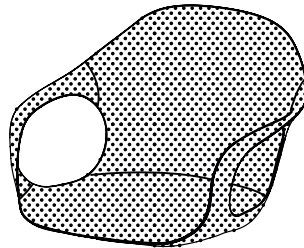

Fabric-upholstered seat

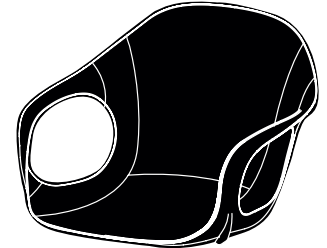

Hide-upholstered seat



Four legs

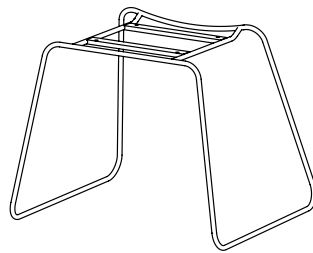

Slide frame

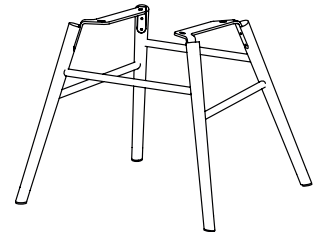

Wooden base

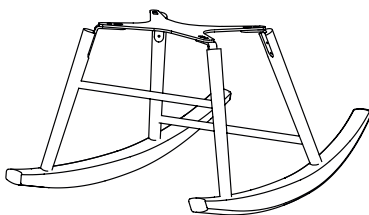

Rocking

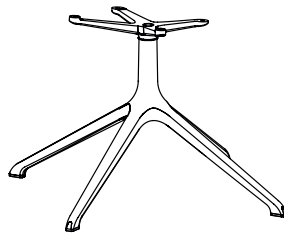

Swivel trestle

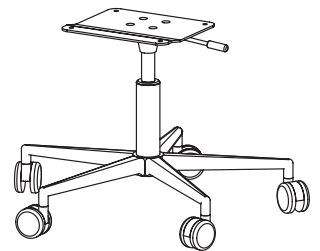

5-spoke base

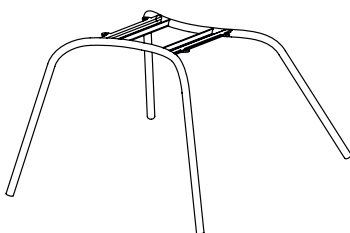

Lounge

ELEPHANT

Four legs - Polyurethane seat

Base finish:

- Polished chrome steel
- Black chrome steel
- Satin chrome steel
- Brass-effect steel
- Lacquered steel (in the same colour as the polyurethane)

Body finish:

- White polyurethane (P001)
- Black polyurethane (P003)
- Beige polyurethane (P004)
- Terracotta brown polyurethane (P006)
- Olive green polyurethane (P008)
- Ruby red polyurethane (P010)
- London grey polyurethane (P011)
- Dust blue polyurethane (P012)

Elephant cushion cover finish:

- A = Valencia (synthetic leather), COM (Customer fabric)
- B = Field 2
- C = Clara 2, Merit
- D = Curmi, Patio, Remix 2
- E = Canvas 2, Hero, Melange Nap
- F = Regal, Scuba, Steelcut Trio 3
- G = Divina Melange 3, Hallingdal 65
- H = Twill Weave

Lips cushion cover finish:

- A = COM (Customer fabric)
- B = Field 2

Note:

For COM orders see inside cover.

For info on fabric composition, see inside cover.

FEET:

Standard in hard plastic. On request we supply feet with felt insert for wooden floors.

SHIPPING INFO PRODUCTS DISASSEMBLED:

For orders of more than 8 units, chairs will be shipped knocked down (only armchairs with polyurethane seat).

- 4 seats = 1 pack - Kg 19 / m³ 0,41.

- 4 bases = 1 pack - Kg 14 / m³ 0,26.

Elephant cushion consumption: 0,55 ml (H. 140 cm).

Lips cushion consumption: 0,5 ml (H. 140 cm).

Reinforced packaging, see inside cover.

Code	Base	Body	pack	m ³	Kg
		Polyurethane			
05ELE11	Lacquered steel, Polished chrome steel, Black chrome steel		1	0,4	10
	Brass-effect steel, Satin steel				

1 armchair in each package

Optionals

Code	Description	Cover											pack	m ³	Kg			
		A	B	C	D	E	F	G	H	L1	L2	L3						
20ELE01	Elephant removable cushion (not removable cover)												-	-	-	1	0,02	1
20LIR01	LIPS-R removable cushion (not removable cover)			-	-	-	-	-	-	-	-	-	-	-	-	1	0,01	1
20LIS01	LIPS-S removable cushion (not removable cover)			-	-	-	-	-	-	-	-	-	-	-	-	1	0,01	1
02PIE03	Set of felt feet															-	-	-

ELEPHANT (20ELE01)

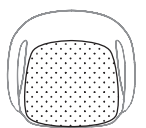

kg
0,6

LIPS-R (20LIR01)

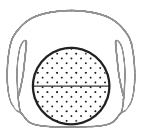

kg
0,6

LIPS-S (20LIS01)



kg
0,6

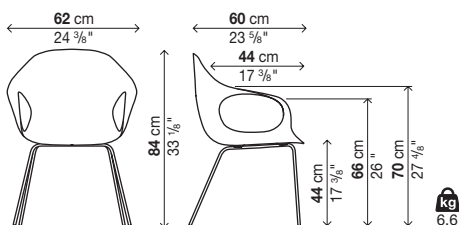

ELEPHANT

Four legs - Hide upholstered seat (not removable)

Base finish:

Polished chrome steel
 Black chrome steel
 Satin chrome steel
 Brass-effect steel
 Lacquered steel (in the same colour as the polyurethane)

Finish of cover:

"Cuoietto" (C) hide
 Natural or black full grain hide (PF)

Note:

Important: sizes and finishes marked with (!) require longer production lead time, about 6 weeks from the date of the order.

For stitching and edge colours refer to "colour chart" on inside cover.

FEET:

Standard in hard plastic. On request we supply feet with felt insert for wooden floors.

Reinforced packaging, see inside cover.

Code	Base	Body		pack	m ³	Kg
		Cuoietto (C) hide (!)	"Full-grain" hide (PF) (!)			
05ELE01	Lacquered steel, Polished chrome steel, Black chrome steel			1	0,4	11,5
	Brass-effect steel, Satin steel					

1 armchair in each package

Optionals

Code	Description	pack	m ³	Kg
02PIE03	Set of felt feet	-	-	-

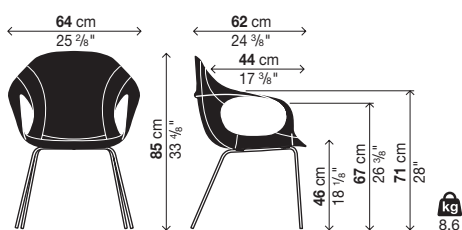

ELEPHANT

Four legs - Fabric upholstered seat (not removable)

Base finish:

Polished chrome steel
 Black chrome steel
 Satin chrome steel
 Brass-effect steel
 Lacquered steel (in the same colours as the polyurethane)

Finish of cover:

B = COM (Customer fabric)
 D = Remix 2
 E = Canvas 2, Hero, Melange Nap
 F = Regal, Steelcut Trio 3
 G = Divina Melange 3, Hallingdal 65
 H = Twill Weave

Note:

For COM orders see inside cover.

For info on fabric composition, see inside cover.

FEET:

Standard in hard plastic. On request we supply feet with felt insert for wooden floors.

COM consumption: 1,5 ml (H. 140 cm).

Reinforced packaging, see inside cover.

Code	Base	Cover											pack	m ²	Kg	
		A	B	C	D	E	F	G	H	L1	L2	L3				
05ELE51	Lacquered steel, Polished chrome steel, Black chrome steel	-		-							-	-	-	1	0,4	11
	Brass-effect steel, Satin steel	-		-							-	-	-			

1 armchair in each package

Optionals

Code	Description	pack	m ²	Kg
02PIE03	Set of felt feet	-	-	-

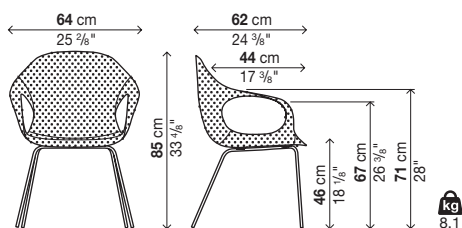

ELEPHANT

Slide frame - Polyurethane seat

Base finish:

Polished chrome steel
 Black chrome steel
 Satin chrome steel
 Brass-effect steel
 Lacquered steel (in the same colour as the polyurethane)

Body finish:

White polyurethane (P001)
 Black polyurethane (P003)
 Beige polyurethane (P004)
 Terracotta brown polyurethane (P006)
 Olive green polyurethane (P008)
 Ruby red polyurethane (P010)
 London grey polyurethane (P011)
 Dust blue polyurethane (P012)

Elephant cushion cover finish:

A = Valencia (synthetic leather), COM (Customer fabric)
 B = Field 2
 C = Clara 2, Merit
 D = Curmi, Patio, Remix 2
 E = Canvas 2, Hero, Melange Nap
 F = Regal, Scuba, Steelcut Trio 3
 G = Divina Melange 3, Hallingdal 65
 H = Twill Weave

Lips cushion cover finish:

A = COM (Customer fabric)
 B = Field 2

Note:

For COM orders see inside cover.

For info on fabric composition, see inside cover.

FEET:

Standard in hard plastic. On request we supply feet with felt insert for wooden floors.

SHIPPING INFO PRODUCTS DISASSEMBLED:

For orders of more than 8 units, chairs will be shipped knocked down (only armchairs with polyurethane seat).

- 4 seats = 1 pack - Kg 19 / m³ 0,41
 - 4 bases = 1 pack - Kg 19 / m³ 0,26

Elephant cushion consumption: 0,55 ml (H. 140 cm).

Lips cushion consumption: 0,5 ml (H. 140 cm).

Reinforced packaging, see inside cover.

Code	Base	Body	
			pack m ³ Kg
		Polyurethane	
05ELE12	Lacquered steel, Polished chrome steel, Black chrome steel		1 0,4 11,2
	Brass-effect steel, Satin steel		

1 armchair in each package

Optionals

Code	Description	Cover										pack m ³ Kg	
		A	B	C	D	E	F	G	H	L1	L2		L3
20ELE01	Elephant removable cushion (not removable cover)									-	-	-	1 0,02 1
20LIR01	LIPS-R removable cushion (not removable cover)			-	-	-	-	-	-	-	-	-	1 0,01 1
20LIS01	LIPS-S removable cushion (not removable cover)			-	-	-	-	-	-	-	-	-	1 0,01 1
02PIE03	Set of felt feet												- - -

ELEPHANT (20ELE01)



LIPS-R (20LIR01)

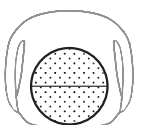

LIPS-S (20LIS01)

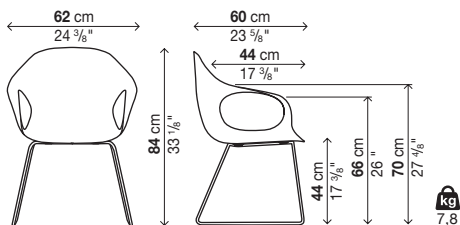

ELEPHANT

Slide frame - Hide upholstered seat (not removable)

Base finish:

Polished chrome steel
 Black chrome steel
 Satin chrome steel
 Brass-effect steel
 Lacquered steel (in the same colour as the polyurethane)

Finish of cover:

"Cuoietto" (C) hide
 Natural or black full grain hide (PF)

Note:

Important: sizes and finishes marked with (!) require longer production lead time, about 6 weeks from the date of the order.

For stitching and edge colours refer to "colour chart" on inside cover.

FEET:

Standard in hard plastic. On request we supply feet with felt insert for wooden floors.

Reinforced packaging, see inside cover.

Code	Base	Body		pack	m ³	Kg
		Cuoietto (C) hide (!)	"Full-grain" hide (PF) (!)			
05ELE02	Lacquered steel, Polished chrome steel, Black chrome steel			1	0,4	13
	Brass-effect steel, Satin steel					

1 armchair in each package

Optionals

Code	Description	pack	m ³	Kg
02PIE03	Set of felt feet	-	-	-

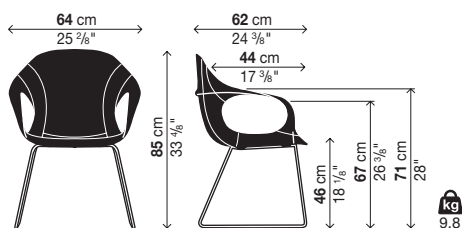

ELEPHANT

Slide frame - Fabric upholstered seat (not removable)

Base finish:

Polished chrome steel
 Black chrome steel
 Satin chrome steel
 Brass-effect steel
 Lacquered steel (in the same colours as the polyurethane)

Finish of cover:

B = COM (Customer fabric)
 D = Remix 2
 E = Canvas 2, Hero, Melange Nap
 F = Regal, Steelcut Trio 3
 G = Divina Melange 3, Hallingdal 65
 H = Twill Weave

Note:

For COM orders see inside cover.

For info on fabric composition, see inside cover.

FEET:

Standard in hard plastic. On request we supply feet with felt insert for wooden floors.

COM consumption: 1,5 ml (H. 140 cm).

Reinforced packaging, see inside cover.

Code	Base	Cover										pack	m ²	Kg		
		A	B	C	D	E	F	G	H	L1	L2				L3	
05ELE52	Lacquered steel, Polished chrome steel, Black chrome steel	-		-							-	-	-	1	0,4	12,5
	Brass-effect steel, Satin steel	-		-							-	-	-			

1 armchair in each package

Optionals

Code	Description	pack	m ²	Kg
02PIE04	Set of felt feet	-	-	-

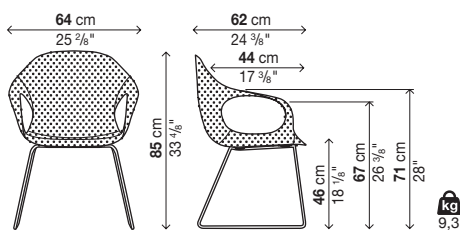

ELEPHANT

Wooden base - Polyurethane seat

Base finish:

Solid beech
Solid european oak
Walnut stained solid oak
Lacquered solid wood (in the same colours as the polyurethane)

Body finish:

White polyurethane (P001)
Black polyurethane (P003)
Beige polyurethane (P004)
Terracotta brown polyurethane (P006)
Olive green polyurethane (P008)
Ruby red polyurethane (P010)
London grey polyurethane (P011)
Dust blue polyurethane (P012)

Elephant cushion cover finish:

A = Valencia (synthetic leather), COM (Customer fabric)
B = Field 2
C = Clara 2, Merit
D = Curmi, Patio, Remix 2
E = Canvas 2, Hero, Melange Nap
F = Regal, Scuba, Steelcut Trio 3
G = Divina Melange 3, Hallingdal 65
H = Twill Weave

Lips cushion cover finish:

A = COM (Customer fabric)
B = Field 2

Note:

For COM orders see inside cover.

For info on fabric composition, see inside cover.

FEET:

Standard in hard plastic. On request we supply feet with felt insert for wooden floors.

SHIPPING INFO PRODUCTS DISASSEMBLED:

For orders of more than 8 units, chairs will be shipped knocked down (only armchairs with polyurethane seat).

- 4 seats = 1 pack - Kg 19 / m³ 0,41

- 4 bases = 1 pack - Kg 12 / m³ 0,33

Elephant cushion consumption: 0,55 ml (H. 140 cm).

Lips cushion consumption: 0,5 ml (H. 140 cm).

Reinforced packaging, see inside cover.

Code	Base	Body		
		pack	m ³	Kg
		Polyurethane		
05ELE82	Beech			
	European oak, Walnut stained oak, Lacquered wood	1	0,4	9,3

1 armchair in each package

Optionals

Code	Description	Cover											pack	m ³	Kg	
		A	B	C	D	E	F	G	H	L1	L2	L3				
20ELE01	Elephant removable cushion (not removable cover)										-	-	-	1	0,02	1
20LIR01	LIPS-R removable cushion (not removable cover)			-	-	-	-	-	-	-	-	-	-	1	0,01	1
20LIS01	LIPS-S removable cushion (not removable cover)			-	-	-	-	-	-	-	-	-	-	1	0,01	1
02PIE05	Set of felt feet															

ELEPHANT (20ELE01)

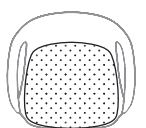

kg
0,6

LIPS-R (20LIR01)

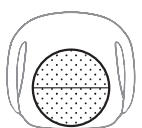

kg
0,6

LIPS-S (20LIS01)

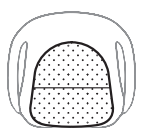

kg
0,6

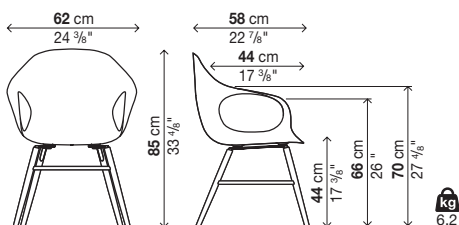

ELEPHANT

Wooden base - Hide upholstered seat (not removable)

Base finish:

Solid beech
 Solid european oak
 Walnut stained solid oak
 Lacquered solid wood (in the same colours as the polyurethane)

Finish of cover:

"Cuoietto" (C) hide
 Natural or black full grain hide (PF)

Note:

Important: sizes and finishes marked with (!) require longer production lead time, about 6 weeks from the date of the order.

For stitching and edge colours refer to "colour chart" on inside cover.

FEET:

Standard in hard plastic. On request we supply feet with felt insert for wooden floors.

Reinforced packaging, see inside cover.

Code	Base	Body		pack	m³	Kg
		Cuoietto (C) hide (!)	"Full-grain" hide (PF) (!)			
05ELE81	Beech			1	0,38	11,2
	European oak, Walnut stained oak, Lacquered wood					

1 armchair in each package

Optionals

Code	Description	pack	m³	Kg
02PIE05	Set of felt feet	-	-	-

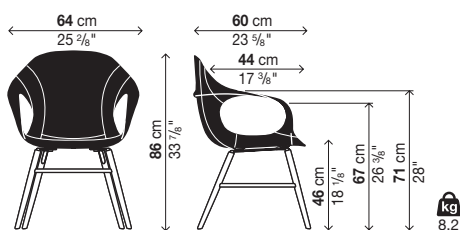

ELEPHANT

Wooden base - Fabric upholstered seat (not removable)

Base finish:

Solid beech
 Solid european oak
 Walnut stained solid oak
 Lacquered solid wood (in the same colours as the polyurethane)

Finish of cover:

B = COM (Customer fabric)
 D = Remix 2
 E = Canvas 2, Hero, Melange Nap
 F = Regal, Steelcut Trio 3
 G = Divina Melange 3, Hallingdal 65
 H = Twill Weave

Note:

For COM orders see inside cover.

For info on fabric composition, see inside cover.

FEET:

Standard in hard plastic. On request we supply feet with felt insert for wooden floors.

COM consumption: 1,5 ml (H. 140 cm).

Reinforced packaging, see inside cover.

Code	Base	Cover											pack	m ³	Kg	
		A	B	C	D	E	F	G	H	L1	L2	L3				
05ELE53	Beech	-		-							-	-	-	1	0,4	10,7
	European oak, Walnut stained oak, Lacquered wood	-		-							-	-	-			

1 armchair in each package

Optionals

Code	Description	pack	m ³	Kg
02PIE05	Set of felt feet	-	-	-

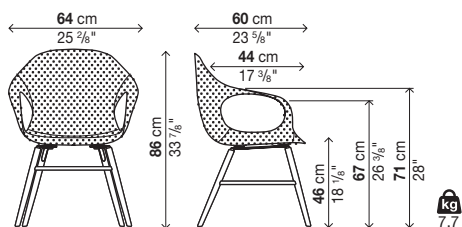

ELEPHANT

Rocking - Polyurethane seat

Base finish:

Solid beech
Solid european oak
Walnut stained solid oak
Lacquered solid wood (in the same colours as the polyurethane)

Body finish:

White polyurethane (P001)
Black polyurethane (P003)
Beige polyurethane (P004)
Terracotta brown polyurethane (P006)
Olive green polyurethane (P008)
Ruby red polyurethane (P010)
London grey polyurethane (P011)
Dust blue polyurethane (P012)

Elephant cushion cover finish:

A = Valencia (synthetic leather), COM (Customer fabric)
B = Field 2
C = Clara 2, Merit
D = Curmi, Patio, Remix 2
E = Canvas 2, Hero, Melange Nap
F = Regal, Scuba, Steelcut Trio 3
G = Divina Melange 3, Hallingdal 65
H = Twill Weave

Lips cushion cover finish:

A = COM (Customer fabric)
B = Field 2

Note:

For COM orders see inside cover.

For info on fabric composition, see inside cover.

SHIPPING INFO PRODUCTS DISASSEMBLED:

For orders of more than 8 units, chairs will be shipped knocked down (only armchairs with polyurethane seat).
- 4 seats = 1 pack - Kg 19 / m³ 0,41
- 2 bases = 1 pack - Kg 10 / m³ 0,34

Elephant cushion consumption: 0,55 ml (H. 140 cm).

Lips cushion consumption: 0,5 ml (H. 140 cm).

Reinforced packaging, see inside cover.

Code	Base	Body	
			pack m ³ Kg
		Polyurethane	
05ELE91	Beech		
	European oak, Walnut stained oak, Lacquered wood		1 0,56 12

1 armchair in each package

Optionals

Code	Description	Cover										pack m ³ Kg		
		A	B	C	D	E	F	G	H	L1	L2		L3	
20ELE01	Elephant removable cushion (not removable cover)										-	-	-	1 0,02 1
20LIR01	LIPS-R removable cushion (not removable cover)			-	-	-	-	-	-	-	-	-	-	1 0,01 1
20LIS01	LIPS-S removable cushion (not removable cover)			-	-	-	-	-	-	-	-	-	-	1 0,01 1

ELEPHANT (20ELE01)

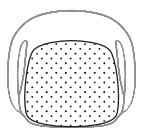

kg
0,6

LIPS-R (20LIR01)

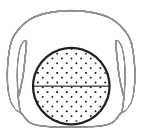

kg
0,6

LIPS-S (20LIS01)

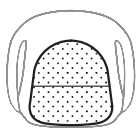

kg
0,6

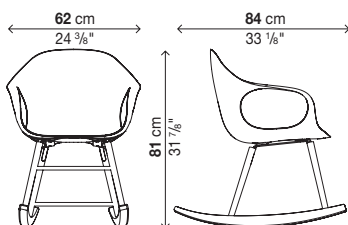

ELEPHANT

Rocking - Hide upholstered seat (not removable)

Base finish:

Solid beech
 Solid european oak
 Walnut stained solid oak
 Lacquered solid wood (in the same colours as the polyurethane)

Finish of cover:

"Cuoietto" (C) hide
 Natural or black full grain hide (PF)

Note:

Important: sizes and finishes marked with (!) require longer production lead time, about 6 weeks from the date of the order.

For stitching and edge colours refer to "colour chart" on inside cover.

Reinforced packaging, see inside cover.

Code	Base	Body		pack	m ³	Kg
		Cuoietto (C) hide (!)	"Full-grain" hide (PF) (!)			
05ELE92	Beech			1	0,56	14
	European oak, Walnut stained oak, Lacquered wood					

1 armchair in each package

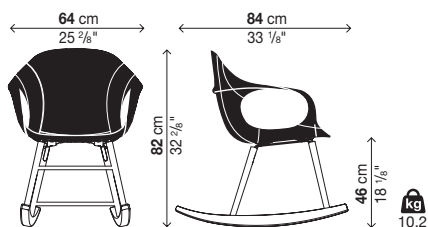

ELEPHANT

Rocking - Fabric upholstered seat (not removable)

Base finish:

Solid beech
 Solid european oak
 Walnut stained solid oak
 Lacquered solid wood (in the same colours as the polyurethane)

Finish of cover:

B = COM (Customer fabric)
 D = Remix 2
 E = Canvas 2, Hero, Melange Nap
 F = Regal, Steelcut Trio 3
 G = Divina Melange 3, Hallingdal 65
 H = Twill Weave

Note:

For COM orders see inside cover.
 For info on fabric composition, see inside cover.
 COM consumption: 1,5 ml (H. 140 cm).
 Reinforced packaging, see inside cover.

Code	Base	Cover											pack	m ³	Kg	
		A	B	C	D	E	F	G	H	L1	L2	L3				
05ELE93	Beech	-		-							-	-	-	1	0,56	13,5
	European oak, Walnut stained oak, Lacquered wood	-		-							-	-	-			

1 armchair in each package

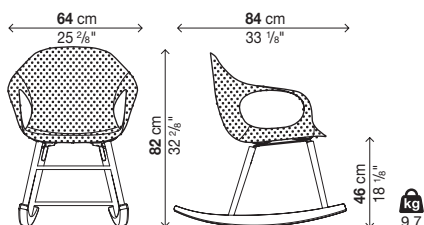

ELEPHANT

Swivel trestle - Polyurethane seat

Base finish:

Polished aluminium

Lacquered aluminium (in the same colours as the polyurethane)

Body finish:

White polyurethane (P001)

Black polyurethane (P003)

Beige polyurethane (P004)

Terracotta brown polyurethane (P006)

Olive green polyurethane (P008)

Ruby red polyurethane (P010)

London grey polyurethane (P011)

Dust blue polyurethane (P012)

Elephant cushion cover finish:

A = Valencia (synthetic leather), COM (Customer fabric)

B = Field 2

C = Clara 2, Merit

D = Curmi, Patio, Remix 2

E = Canvas 2, Hero, Melange Nap

F = Regal, Scuba, Steelcut Trio 3

G = Divina Melange 3, Hallingdal 65

H = Twill Weave

Lips cushion cover finish:

A = COM (Customer fabric)

B = Field 2

Note:

For COM orders see inside cover.

For info on fabric composition, see inside cover.

FEET:

Standard with felt insert for wooden floors.

SHIPPING INFO PRODUCTS DISASSEMBLED:

For orders of more than 8 units, chairs will be shipped knocked down (only armchairs with polyurethane seat).

- 4 seats = 1 pack - Kg 19 / m³ 0,41

- 1 bases = 1 pack - Kg 6 / m³ 0,14

Elephant cushion consumption: 0,55 ml (H. 140 cm).

Lips cushion consumption: 0,5 ml (H. 140 cm).

Reinforced packaging, see inside cover.

Code	Base	Body		pack	m ³	Kg
			Polyurethane			
05ELE72	Lacquered aluminium			1	0,38	11,5
	Polished aluminium					

1 armchair in each package

Optionals

Code	Description	Cover											pack	m ³	Kg			
		A	B	C	D	E	F	G	H	L1	L2	L3						
20ELE01	Elephant removable cushion (not removable cover)												-	-	-	1	0,02	1
20LIR01	LIPS-R removable cushion (not removable cover)			-	-	-	-	-	-	-	-	-	-	-	-	1	0,01	1
20LIS01	LIPS-S removable cushion (not removable cover)			-	-	-	-	-	-	-	-	-	-	-	-	1	0,01	1

ELEPHANT (20ELE01)

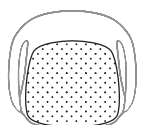

LIPS-R (20LIR01)

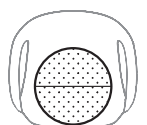

LIPS-S (20LIS01)

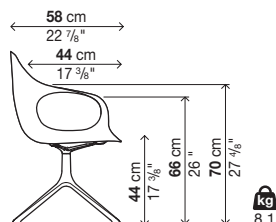
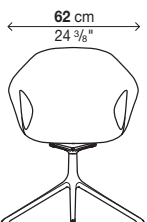
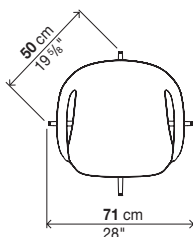

ELEPHANT

Swivel trestle - Hide upholstered seat (not removable)

Base finish:

Polished aluminium
Lacquered aluminium (in the same colours as the polyurethane)

Finish of cover:

"Cuoietto" (C) hide
Natural or black full grain hide (PF)

Note:

Important: sizes and finishes marked with (!) require longer production lead time, about 6 weeks from the date of the order.

For stitching and edge colours refer to "colour chart" on inside cover.

FEET:

Standard with felt insert for wooden floors.

Reinforced packaging, see inside cover.

Code	Base	Body		pack	m ³	Kg
		Cuoietto (C) hide (!)	"Full-grain" hide (PF) (!)			
05ELE71	Lacquered aluminium			1	0,38	14
	Polished aluminium					

1 armchair in each package

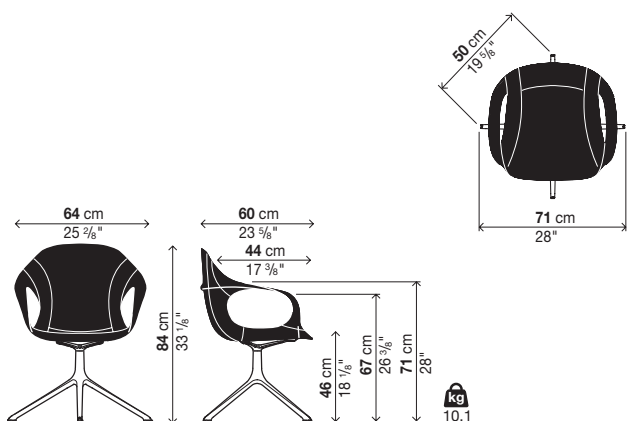

ELEPHANT

Swivel trestle - Fabric upholstered seat (not removable)

Base finish:

Polished aluminium

Lacquered aluminium (in the same colours as the polyurethane)

Finish of cover:

B = COM (Customer fabric)

D = Remix 2

E = Canvas 2, Hero, Melange Nap

F = Regal, Steelcut Trio 3

G = Divina Melange 3, Hallingdal 65

H = Twill Weave

Note:

For COM orders see inside cover.

For info on fabric composition, see inside cover.

FEET:

Standard with felt insert for wooden floors.

COM consumption: 1,5 ml (H. 140 cm).

Reinforced packaging, see inside cover.

Code	Base	Cover											pack	m ²	Kg	
		A	B	C	D	E	F	G	H	L1	L2	L3				
05ELE54	Lacquered aluminium	-		-							-	-	-	1	0,38	13,5
	Polished aluminium	-		-							-	-	-			

1 armchair in each package

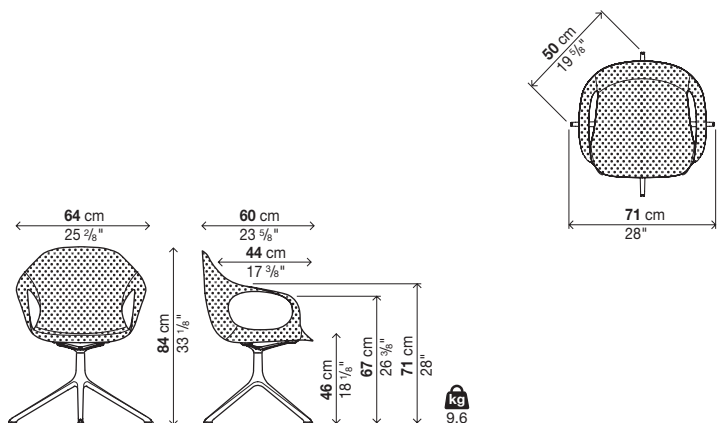

ELEPHANT

5 spoke base with castors - Polyurethane seat

Base finish:

Polished aluminium
Lacquered aluminium (white, black)

Body finish:

White polyurethane (P001)
Black polyurethane (P003)
Beige polyurethane (P004)
Terracotta brown polyurethane (P006)
Olive green polyurethane (P008)
Ruby red polyurethane (P010)
London grey polyurethane (P011)
Dust blue polyurethane (P012)

Elephant cushion cover finish:

A = Valencia (synthetic leather), COM (Customer fabric)
B = Field 2
C = Clara 2, Merit
D = Curmi, Patio, Remix 2
E = Canvas 2, Hero, Melange Nap
F = Regal, Scuba, Steelcut Trio 3
G = Divina Melange 3, Hallingdal 65
H = Twill Weave

Lips cushion cover finish:

A = COM (Customer fabric)
B = Field 2

Note:

For COM orders see inside cover.

For info on fabric composition, see inside cover.

Soft tread, self-locking swivel castors.

SHIPPING INFO PRODUCTS DISASSEMBLED:

For orders of more than 8 units, chairs will be shipped knocked down (only armchairs with polyurethane seat).

- 4 seats = 1 pack - Kg 19 / m³ 0,41
- 1 bases = 1 pack - Kg 15 / m³ 0,14

Elephant cushion consumption: 0,55 ml (H. 140 cm).

Lips cushion consumption: 0,5 ml (H. 140 cm).

Reinforced packaging, see inside cover.

Code	Base	Body		
		pack	m ³	Kg
		Polyurethane		
05ELE41	Lacquered aluminium	1	0,38	13
	Polished aluminium			

1 armchair in each package

Optionals

Code	Description	Cover										pack	m ³	Kg			
		A	B	C	D	E	F	G	H	L1	L2				L3		
20ELE01	Elephant removable cushion (not removable cover)											-	-	-	1	0,02	1
20LIR01	LIPS-R removable cushion (not removable cover)			-	-	-	-	-	-	-	-	-	-	-	1	0,01	1
20LIS01	LIPS-S removable cushion (not removable cover)			-	-	-	-	-	-	-	-	-	-	-	1	0,01	1

ELEPHANT (20ELE01)

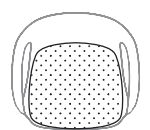

LIPS-R (20LIR01)

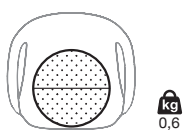

LIPS-S (20LIS01)

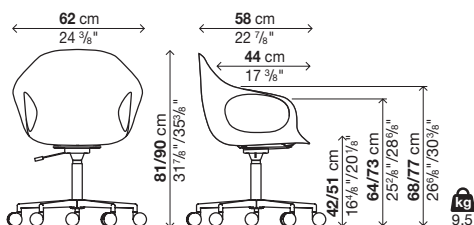
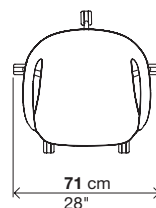
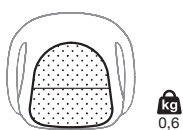

ELEPHANT

5 spoke base with castors - Hide upholstered seat (not removable)

Base finish:

Polished aluminium
Lacquered aluminium (white, black)

Finish of cover:

"Cuoietto" (C) hide
Natural or black full grain hide (PF)

Note:

Important: sizes and finishes marked with (!) require longer production lead time, about 6 weeks from the date of the order.

For stitching and edge colours refer to "colour chart" on inside cover.

Soft tread, self-locking swivel castors.

Reinforced packaging, see inside cover.

Code	Base	Body		pack	m ³	Kg
		Cuoietto (C) hide (!)	"Full-grain" hide (PF) (!)			
05ELE42	Lacquered aluminium			1	0,38	15,5
	Polished aluminium					

1 armchair in each package

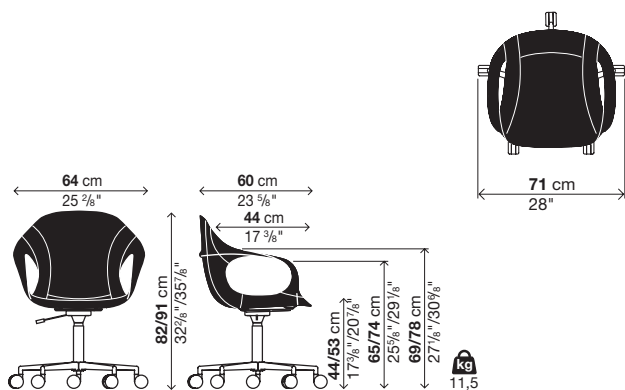

ELEPHANT

5 spoke base with castors - Fabric upholstered seat (not removable)

Base finish:

Polished aluminium
Lacquered aluminium (white, black)

Finish of cover:

B = COM (Customer fabric)
D = Remix 2
E = Canvas 2, Hero, Melange Nap
F = Regal, Steelcut Trio
G = Divina Melange 3, Hallingdal 65
H = Twill Weave

Note:

For COM orders see inside cover.

For info on fabric composition, see inside cover.

Soft tread, self-locking swivel castors.

COM consumption: 1,5 ml (H. 140 cm).

Reinforced packaging, see inside cover.

Code	Base	Cover										pack	m ²	Kg		
		A	B	C	D	E	F	G	H	L1	L2				L3	
05ELE43	Lacquered aluminium	-		-							-	-	-	1	0,38	15
	Polished aluminium	-		-							-	-	-			

1 armchair in each package

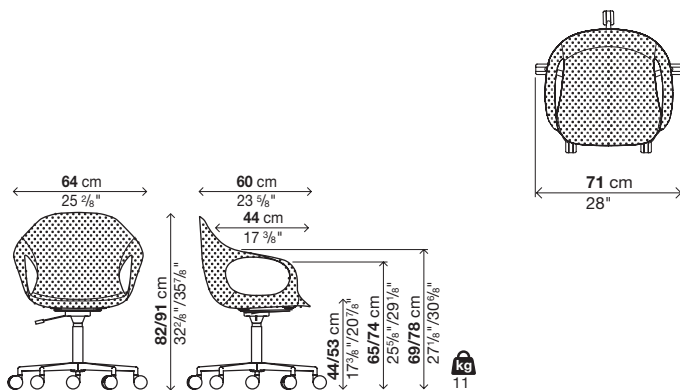

ELEPHANT

Armchair lounge - Polyurethane seat

Base finish:

Polished chrome steel
 Black chrome steel
 Brass-effect steel
 Lacquered steel (in the same colour as the polyurethane)

Body finish:

White polyurethane (P001)
 Black polyurethane (P003)
 Beige polyurethane (P004)
 Terracotta brown polyurethane (P006)
 Olive green polyurethane (P008)
 Ruby red polyurethane (P010)
 London grey polyurethane (P011)
 Dust blue polyurethane (P012)

Elephant cushion cover finish:

A = Valencia (synthetic leather), COM (Customer fabric)
 B = Field 2
 C = Clara 2, Merit
 D = Curmi, Patio, Remix 2
 E = Canvas 2, Hero, Melange Nap
 F = Regal, Scuba, Steelcut Trio 3
 G = Divina Melange 3, Hallingdal 65
 H = Twill Weave

Lips cushion cover finish:

A = COM (Customer fabric)
 B = Field 2

Note:

For COM orders see inside cover.

For info on fabric composition, see inside cover.

FEET:

Standard in hard plastic. On request we supply feet with felt insert for wooden floors.

SHIPPING INFO PRODUCTS DISASSEMBLED:

For orders of more than 8 units, chairs will be shipped knocked down (only armchairs with polyurethane seat).

- 4 seats = 1 pack - Kg 19 / m³ 0,41

- 4 bases = 1 pack - Kg 14 / m³ 0,28

Elephant cushion consumption: 0,55 ml (H. 140 cm).

Lips cushion consumption: 0,5 ml (H. 140 cm).

Reinforced packaging, see inside cover.

Code	Base	Body		
		pack	m ³	Kg
		Polyurethane		
05ELE03	Lacquered steel, Polished chrome steel, Black chrome steel	1	0,4	10
	Brass-effect steel			

1 armchair in each package

Optionals

Code	Description	Cover										pack	m ³	Kg		
		A	B	C	D	E	F	G	H	L1	L2				L3	
20ELE01	Elephant removable cushion (not removable cover)										-	-	-	1	0,02	1
20LIR01	LIPS-R removable cushion (not removable cover)			-	-	-	-	-	-	-	-	-	-	1	0,01	1
20LIS01	LIPS-S removable cushion (not removable cover)			-	-	-	-	-	-	-	-	-	-	1	0,01	1
02PIE14	Set of felt feet													-	-	-

ELEPHANT (20ELE01)

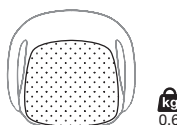

LIPS-R (20LIR01)

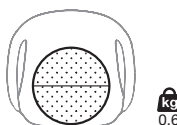

LIPS-S (20LIS01)

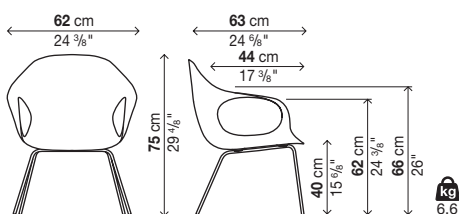

ELEPHANT

Armchair lounge - Hide upholstered seat (not removable)

Base finish:

Polished chrome steel
 Black chrome steel
 Brass-effect steel
 Lacquered steel (in the same colour as the polyurethane)

Finish of cover:

"Cuoietto" (C) hide
 Natural or black full grain hide (PF)

Note:

Important: sizes and finishes marked with (!) require longer production lead time, about 6 weeks from the date of the order.

For stitching and edge colours refer to "colour chart" on inside cover.

Reinforced packaging, see inside cover.

Code	Base	Body		pack	m ²	Kg
		Cuoietto (C) hide (!)	"Full-grain" hide (PF) (!)			
05ELE13	Lacquered steel, Polished chrome steel, Black chrome steel			1	0,4	11,5
	Brass-effect steel					

1 armchair in each package

Optionals

Code	Description	pack	m ²	Kg
02PIE14	Set of felt feet	-	-	-

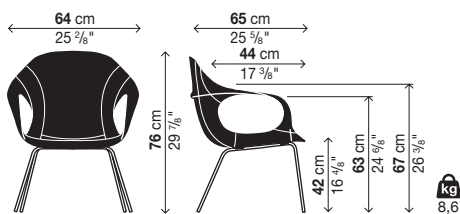

ELEPHANT

Armchair lounge - Fabric upholstered seat (not removable)

Base finish:

Polished chrome steel
 Black chrome steel
 Brass-effect steel
 Lacquered steel (in the same colours as the polyurethane)

Finish of cover:

B = COM (Customer fabric)
 D = Remix 2
 E = Canvas 2, Hero, Melange Nap
 F = Regal, Steelcut Trio 3
 G = Divina Melange 3, Hallingdal 65
 H = Twill Weave

Note:

For COM orders see inside cover.

For info on fabric composition, see inside cover.

FEET:

Standard in hard plastic. On request we supply feet with felt insert for wooden floors.

COM consumption: 1,5 ml (H. 140 cm).

Reinforced packaging, see inside cover.

Code	Base	Cover										pack	m ³	Kg	
		A	B	C	D	E	F	G	H	L1	L2				L3
05ELE23	Lacquered steel, Polished chrome steel, Black chrome steel	-		-						-	-	-	1	0,4	11
	Brass-effect steel	-		-						-	-	-			

1 armchair in each package

Optionals

Code	Description	pack	m ³	Kg
02PIE14	Set of felt feet	-	-	-

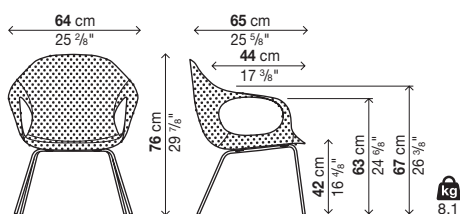

Elephant

Four legs/Slide frame

Metal finish:

Lacquered steel (in the same colours as the polyurethane)

Body finish:

White polyurethane (PO01)

Black polyurethane (PO03)

Beige polyurethane (PO04)

Terracotta brown polyurethane (PO06)

Olive green polyurethane (PO08)

Ruby red polyurethane (PO10)

London grey polyurethane (PO11)

Dust blue polyurethane (PO12)

→ Reinforced packaging, see inside of cover.

→ "Casper" protective cover, see page 74.

→ "Lips" removable cushions, see page 72.

Armchair with legs



Code	Body	Metal finish	Price in EURO	Packs	Vol. ³	Kg
05ELE61	polyurethane	acciaio verniciato		1	0,4	10

1 armchair in each package

Optionals

Code	Price in EURO	Packs	Vol. ³	Kg
02FOR06	Surcharge for hole in the structure to allow water to run off	-	-	-

Chairs will be shipped knocked down for orders of more than 8 units.

	Packs	m ³	Kg
 nr. 4	1	0,41	19
 nr. 4	1	0,26	14

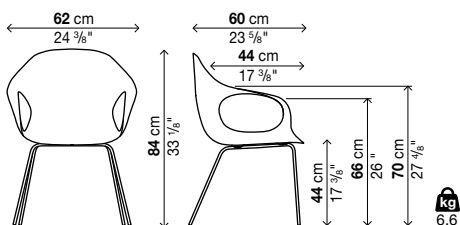

Armchair on a slide frame



Code	Body	Metal finish	Price in EURO	Packs	Vol. ³	Kg
05ELE62	polyurethane	lacquered steel		1	0,4	11,2

1 armchair in each package

Optionals

Code	Price in EURO	Packs	Vol. ³	Kg
02FOR06	Surcharge for hole in the structure to allow water to run off	-	-	-

Chairs will be shipped knocked down for orders of more than 8 units.

	Packs	m ³	Kg
 nr. 4	1	0,41	19
 nr. 4	1	0,26	19

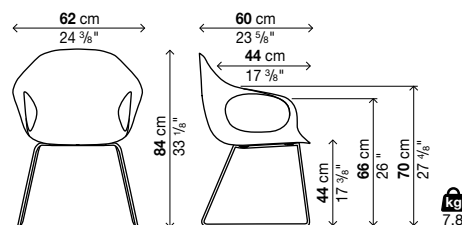

Elephant

Lounge armchair

Metal finish:

Lacquered steel (in the same colours as the polyurethane)

Body finish:

- White polyurethane (PO01)
- Black polyurethane (PO03)
- Beige polyurethane (PO04)
- Terracotta brown polyurethane (PO06)
- Olive green polyurethane (PO08)
- Ruby red polyurethane (PO10)
- London grey polyurethane (PO11)
- Dust blue polyurethane (PO12)

→ Reinforced packaging, see inside of cover.

→ "Casper" protective cover, see page 74.

→ "Lips" removable cushions, see page 72.

Lounge armchair



Code	Body	Metal finish	Price in EURO	Packs	Vol. ³	Kg
05ELE63	polyurethane	lacquered steel		1	0,4	10

1 armchair in each package

Optionals

Code	Price in EURO	Packs	Vol. ³	Kg
02FOR06	Surcharge for hole in the structure to allow water to run off	-	-	-

Chairs will be shipped knocked down for orders of more than 8 units.

	Packs	m ³	Kg
 nr. 4	1	0,41	19
 nr. 4	1	0,28	14

