



> DESK

Melamine wooden tops: wooden particle board thickness 14 mm melamine-coated paper white, rovere naturale, titanio or olmo, ABS edge 1,5 mm. All wood tops are equipped with high-powered magnets fixed on the bottom, to attach them to the perimeter steel structure, the centering of the same is guaranteed by pins located on the top.

Beams: closed profile made of steel plate with triangular section thickness 1.5 mm with continuous welding on the inside, painted with epoxy finish white or titanio. They are equipped with slots on the inside for the attachment of the brackets.

Legs: the upper joint is made of die-cast aluminium-zinc alloy, coated with epoxy powders finishing white or titanio.

The central part of the leg is made of extruded aluminum painted with epoxy powders finishing white or titanio.

The bottom cap is made of die-cast aluminium-zinc alloy, coated with epoxy powders finishing, white or titanio.

Feet leverer made of ABS with steel screw. These three parts are fixed together to make one piece.

The assembling of the perimetral beams and the legs is made by zinc plated corners, with strong thickness, fixed to the corner with a single screw.

> CABLE MANAGEMENT

Horizontal cable management:

Cable port (type C) 260x120 mm made by extruded aluminium with easy access.

Cable port (type D) diameter 80 mm made of die-cast aluminium-zinc alloy, chromed finish with brush.

Cable port (type E) diameter 80 mm made in ABS in aluminium, white or black finish.

Plug in (type G) inside diameter 80 mm, equipped with 2 plugs: data and power, with metal sliding covers white and black finishing.

Power module on top (Type P): built in power socket (Shuko, France, UK) + 1 powered USB port.

Underneath cable management:

metal cable trays, made of steel plate, painted with epoxy powders finish white, aluminum or titanio, available in two types: the tray for single desk, is fixed inside the metal beams with high powered magnets, the tray for bench and meeting table, is fixed on both side to the beams of the structure.

Vertical cable management:

Clip on the leg, made in trasparente ABS, snap on the leg.

Vertebra, made in trasparente ABS, is fixed to the desk top or to the metal tray underneath.

Vertebra for cables, steel made chromed finishing with internal brush.

> MODESTY

The modesty panel it is fixed to the beams, using special supports, on the site you can choose the position of the modesty panel.

Modesty: wooden particle board thickness 18 mm or 30 mm, melamine-coated paper white, titanio, rovere naturale or olmo, ABS edge 1,5 mm.

FINISHES

TOPS TH. 14 MM MELAMINE



038 Bianco

041 Titanio

034 Rovere naturale

030 Olmo

MODESTY MELAMINE



038 Bianco

041 Titanio

034 Rovere naturale

030 Olmo

LEGS / BEAMS METAL



053 Bianco

069 Titanio

AVAILABLE TOP SIZES

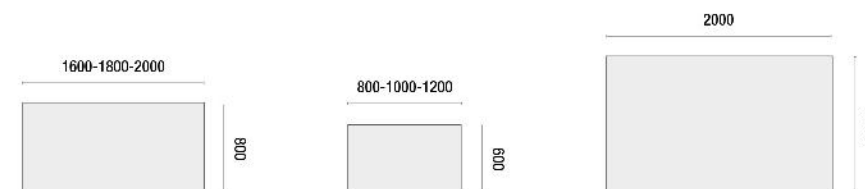

Desk

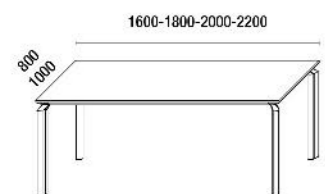

W.	D.	H.	KG	CODE
1600	800	750	33,8	FDAW0015
1800	800	750	36,9	FDAW0020
2000	800	750	39,5	FDAW0025
2000	1000	750	46,6	FDAW0035

Return with assembling brackets included

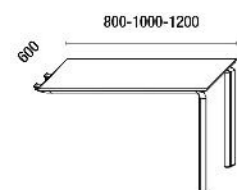

W.	D.	H.	KG	CODE
800	600	750	16	FDAW0130
1000	600	750	20,4	FDAW0135
1200	600	750	22,7	FDAW0140

Desk for structural cabinet, assembling brackets included

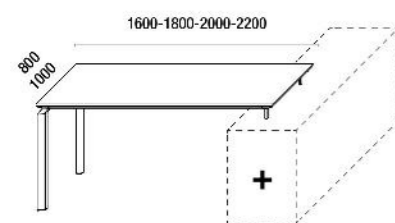

W.	D.	H.	KG	CODE
1600	800	750	28,6	FDAW0210
1800	800	750	31,7	FDAW0215
2000	800	750	34,3	FDAW0220
2000	1000	750	41,4	FDAW0255

⚠ Always add structural cabinet, white or all titanium finish, see page 55

Modesty th. 18 mm

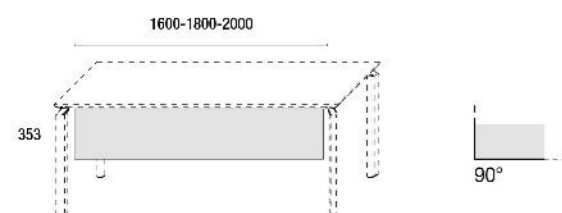

W.TOP	W.	D.	H.	KG	CODE
1600	1428	18	353	6,5	FDAW7009
1800	1628	18	353	7,5	FDAW7011
2000	1828	18	353	8,5	FDAW7013

Modesty Th. 18 mm for desk with cabinet

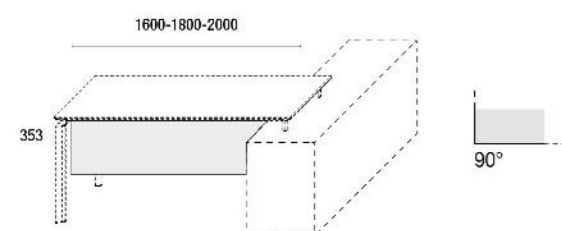

W.TOP	W.	D.	H.	KG	CODE
1600	1065	18	353	5	FDAW7037
1800	1265	18	353	6	FDAW7039
2000	1465	18	353	7	FDAW7041

TOPS TH. 14 MM MELAMINE



LEGS METAL



BEAMS METAL

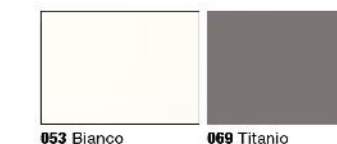

🔍 FOR WIRE MANAGEMENT SEE PAGE 43
 FOR PEDESTALS AND SERVICE UNITS SEE PAGE 54 - 55
 FOR GALAXY STORAGES SEE PAGE 60

Square meetin table

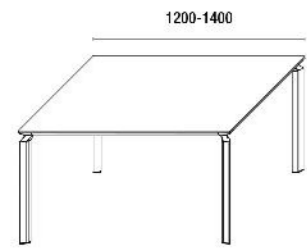

W.	D.	H.	KG	CODE
1200	1200	750	36,1	FDAW0055
1400	1400	750	43,6	FDAW0060

Rectangular meeting

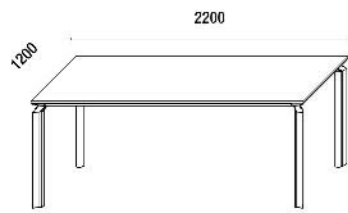

W.	D.	H.	KG	CODE
2200	1200	750	59,5	FDAW0045

Desk - Cable port positioning

Cable port TYPE "C"

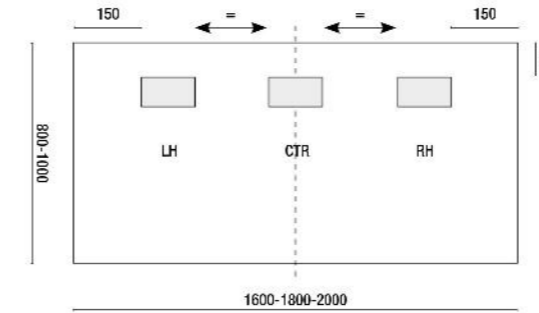

Cable port TYPE "E", "D", "P" and "G"

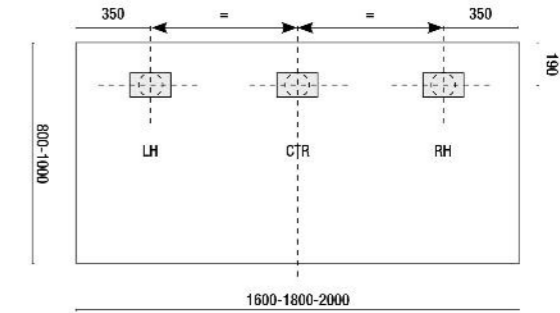

WIRE MANAGEMENT



Clips on leg (4 pieces kit)

KG	CODE	€
-	FDAW9010	13



ABS transparent cables vertebra

KG	CODE	€
0,7	FDMX9005	51



Glossy chrome cables vertebra

KG	CODE	€
0,7	FDMX9007	111

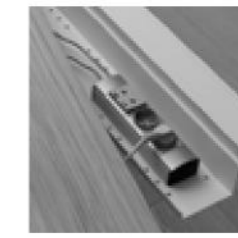

Desk metal cable tray W.600-800 mm white, titanium

W.	KG	CODE	€
600	2,7	FDAW9005	94
800	3	FDAW9007	110



Cable port **TYPE C** 260x120 white, black, aluminium

KG	CODE	€
-	TYPE C	49



ABS cable port **TYPE E** Ø 80 mm white, black, aluminium

KG	CODE	€
-	TYPE E	31



Chrome cable port **TYPE D** Ø 80 mm

KG.	ITEM	€
0,7	TYPE D	81

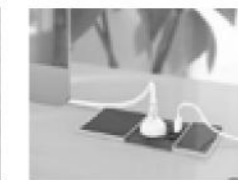

Sliding flap **TYPE G** L.125 P.90 mm white, black

KG.	CODE	€
0,7	FDMX9122	82



Black power module **TYPE P** Ø 80 1 SHUKO + 1 USB

KG	CODE	€
0,1	FDMX9181	47