

NUCLEO



NUCLEO

design studio monica graffeo

“When we think about the office,
we think about people who work there”

Contemporary Office: focus on your wellness

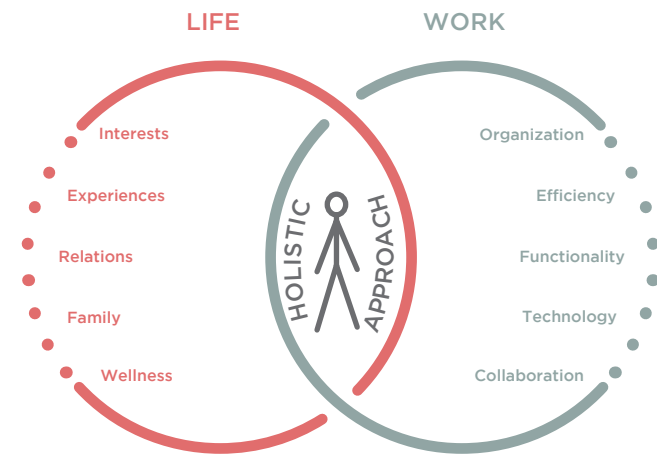

en_In the last twenty years, we witnessed an evolution of work due to many aspects as the development of technology, which has made possible flexible work anywhere and anytime. Also the downfall of traditional sectorial geographic borders, the ever-increasing percentage of female employment, the meeting and clash among generations (baby boomers and millennials) and lastly the ageing of the population. These changes make the balance between work and private life a crucial aspect for companies: they are no longer separated, instead they are more and more related to each other and personal feelings (positive or negative) flow through these two worlds. That's why we have to think and design work spaces thinking about the psychophysical well-being of people. Thus, it is necessary to create a widespread culture of feeling-good in the office with a holistic vision of the individual, that considers the person in his entirety and therefore in all its dimensions: physical, mental, energetic and spiritual. The holistic approach states the need to intervene on a person on several levels but with a single purpose: a real and all-encompassing well-being state. As in holistic medicine the person is studied as a whole and not as the sum of distinct organs and cells, so in architecture the workplace is not the result of walls, infrastructures, furniture, etc., but a single organism that "vibrates" with the people who live it and its surroundings. The challenge for the holistic office is to create environments that respond to the needs of personal life and foster interchange.

it_Negli ultimi venti anni abbiamo assistito ad un'evoluzione del lavoro dovuta a molteplici aspetti quali lo sviluppo della tecnologia, che ha reso possibile il lavoro flessibile ovunque e in qualsiasi momento, la caduta dei tradizionali confini geografici e di settore, il crescente aumento della percentuale di occupazione femminile, l'incontro/scontro di generazioni (baby boomers e millennials) ed infine l'invecchiamento della popolazione. Questi cambiamenti hanno reso cruciale per le aziende il tema del rapporto tra vita privata e vita lavorativa; professionale e domestico, infatti, non sono mai totalmente separati, ma anzi comunicano tra loro, e le emozioni, sia positive che negative, scorrono attraverso questi due mondi. Ecco perché si dovrebbero progettare degli spazi di lavoro pensando al benessere psicofisico delle persone. Bisognerebbe in sostanza creare una cultura diffusa dello stare bene in ufficio con una visione olistica dell'individuo, che consideri la persona nella sua interezza e quindi in tutte le sue dimensioni: fisica, mentale, energetica e spirituale. L'approccio di tipo olistico sancisce la necessità di intervenire su una persona a più livelli ma con un unico scopo: un reale e totalizzante stato di benessere. Come in medicina olistica si studia la persona come un tutt'uno e non come la somma di organi e cellule distinte, così in architettura si pensa allo spazio lavorativo non come la somma di pareti, infrastrutture, impianti, mobili ma come un organismo unico che "vibra" con le persone che lo vivono e con l'ambiente circostante. La sfida dell'ufficio olistico è creare ambienti che rispondano alle esigenze di vita personale ed inneschino interscambio.

fr_Au cours des vingt dernières années, nous avons assisté à une évolution du travail due à de nombreux aspects: le développement de la technologie qui a rendu possible le travail flexible partout et à tout moment, la chute des frontières géographiques et sectorielles traditionnelles, l'augmentation du pourcentage d'emploi féminin, la rencontre/conflit des générations (baby boomers et millennials) et enfin le vieillissement de la population. Ces changements rendent crucial pour les entreprises le thème de la relation entre vie privée et vie professionnelle, qui communiquent entre eux: les émotions, tant positives que négatives, traversent ces deux mondes. C'est pourquoi nous devons concevoir des espaces de travail en pensant au bien-être psychophysique des gens. C'est nécessaire de créer une culture généralisée de se sentir bien dans le bureau avec une vision holistique de l'individu, qui considère la personne dans toutes ses dimensions: physique, mentale, énergétique et spirituelle. Comme dans la médecine holistique, la personne est étudiée dans son ensemble et pas comme la somme d'organes et de cellules distincts: en architecture on ne considère pas l'espace de travail comme la somme des murs, des infrastructures, des implants, mais comme un organisme unique qui "vibre" avec les gens qui le vivent et son environnement. Le défi pour le bureau holistique est de créer des environnements qui répondent aux besoins de la vie personnelle et déclenchent l'échange.

Work

“Let's put man at the center in an experience of daily well-being”

Life

Sensory wellness as emotional nourishment

“We spend most of our time at work and this affects a lot how we feel. The office environment is not only a visual aspect but also a cognitive one, an instrument to enhance our humanity, a framework for life”

en_Our knowledge is a body knowledge: our tissues are littered with billions of neuroreceptors that carry signals to the brain and that influence, in positive or negative way, the perception of reality. Architect and author Sarah Robinson speaks for example of “skin mind”: touching living and stimulating surfaces produces very important effects on our perception, stimulating our imagination and reflection. In today's offices we should create an experience of emotional wellness and nourishment through the stimulation of all 5 senses; designing a space that evokes a series of positive sensations improves the quality of work understood as commitment and socialization.

it_La nostra conoscenza è una conoscenza corporea: i nostri tessuti sono disseminati di miliardi di neurorecettori che portano segnali al cervello e che influenzano in modo positivo o negativo la percezione della realtà. L'architetto Sarah Robinson parla ad esempio di “mente della pelle”: toccare superfici vive e stimolanti produce effetti importantissimi sulla nostra percezione, stimolando la nostra immaginazione e riflessione. Negli uffici di oggi l'obiettivo dovrebbe essere creare un'esperienza di benessere e nutrimento emotivo attraverso la stimolazione di tutti i 5 sensi; progettare uno spazio che evochi una serie di sensazioni positive migliora la qualità del lavoro intesa come impegno e socializzazione.

fr_Notre connaissance est une connaissance du corps: nos tissus sont jonchés de milliards de neurorécepteurs qui transmettent des signaux au cerveau et qui influencent la perception de la réalité de manière positive ou négative. Par exemple, l'architecte Sarah Robinson parle d'«esprit de la peau»: toucher des surfaces vivantes et stimulantes produit des effets très importants sur notre perception, en stimulant notre imagination et notre réflexion. Dans les bureaux d'aujourd'hui, nous devons créer une expérience de bien-être et de nourriture émotionnelle par la stimulation de tous les 5 sens; concevoir un espace qui évoque une série de sensations positives améliore la qualité du travail comprise comme engagement et socialisation.



Get on well with your colleagues: reach your goals



“To put people at ease means to create spaces that respond to their needs and that can create and improve relationships and interactions between people”

en_ Traditionally, the office setting was intended as an individual space, in which separation in independent offices prevailed. Each office, in accordance with the furniture chosen and its location, in fact indicated the role and hierarchy of the people who occupied it. Today, however, the workspace implies continuous communication exchanges and interpersonal relationships, that's why it must respond to the needs and conditions of flexibility required by the new workflows; that favor models of space-organization that encourage teamwork with respect to individual activities. People, roles and different functions find themselves living together in common spaces that should be able to promote the quality of the interaction, and the achievement of the objectives set in terms of efficiency and personal motivation.

it_ Tradizionalmente l'ambiente ufficio era inteso come spazio individuale, in cui prevaleva la separazione in uffici indipendenti; ogni ufficio, in base all'arredo scelto e alla sua collocazione, indicava infatti il ruolo e la gerarchia delle persone che lo occupavano. Oggi invece, lo spazio di lavoro implica continui scambi comunicativi e relazioni interpersonali e deve per questo rispondere ad esigenze e condizioni di flessibilità richieste dai nuovi flussi di lavoro, favorendo modelli di organizzazione dello spazio che incoraggino il lavoro di gruppo rispetto alle attività individuali. Persone, ruoli e funzioni diverse si trovano a dover convivere in spazi comuni che devono essere in grado di favorire la qualità dell'interazione, e il raggiungimento degli obiettivi prefissati, in termini di efficienza e motivazione personale.

fr_ Traditionnellement, l'environnement de bureau était conçu comme un espace individuel où la séparation dans les bureaux indépendants prévalait: chaque bureau, sur la base de mobilier choisi et son emplacement, indiquait le rôle et la hiérarchie des personnes qui l'occupaient; aujourd'hui, l'espace de travail implique des échanges continus de communication et des relations interpersonnelles et doit donc répondre aux besoins et aux conditions de flexibilité requises par les nouveaux workflows, privilégiant les modèles d'organisation spatiale favorisant le travail de groupe par rapport aux activités individuelles. Les personnes, les rôles et les différentes fonctions doivent cohabiter dans des espaces communs qui doivent être capables de promouvoir la qualité de l'interaction, et la réalisation des objectifs fixés en termes d'efficacité et de motivation personnelle.

Our reading key: everything starts from “La Piazza”

en_Martex interpretation of the office evolution, intended as a place of sensory wellness and relationships, is inspired by the concept of the Italian town square: “la piazza”; a space full of diversity and sensory stimuli, which transferred to the work environment allows a personal interpretation, according to attitudes and needs.

The urban metaphor is the interpretative key that best explains the change we are experiencing, because the square is a meeting and exchange place, the nucleus of the community, a complex space in which relationships are grafted and where the main flows of the city meet, a true incubator of relationships at the center of which are the primordial sources of water (the well, the fountain) and food (coffee, kiosk, terrace, etc.). All around the square are structured the common spaces, the spaces for rest, relax and work. As an urban center, furniture support and facilitate the appropriation of space and aggregation, and stimulate us to develop the office environment around a convivial fulcrum, which fosters positive relationships.

“As work blends with life,
people give more value to
experience. Both cities and
work settings are being
reshaped as a result”

(Dialogue 28, A Gensler Publication)

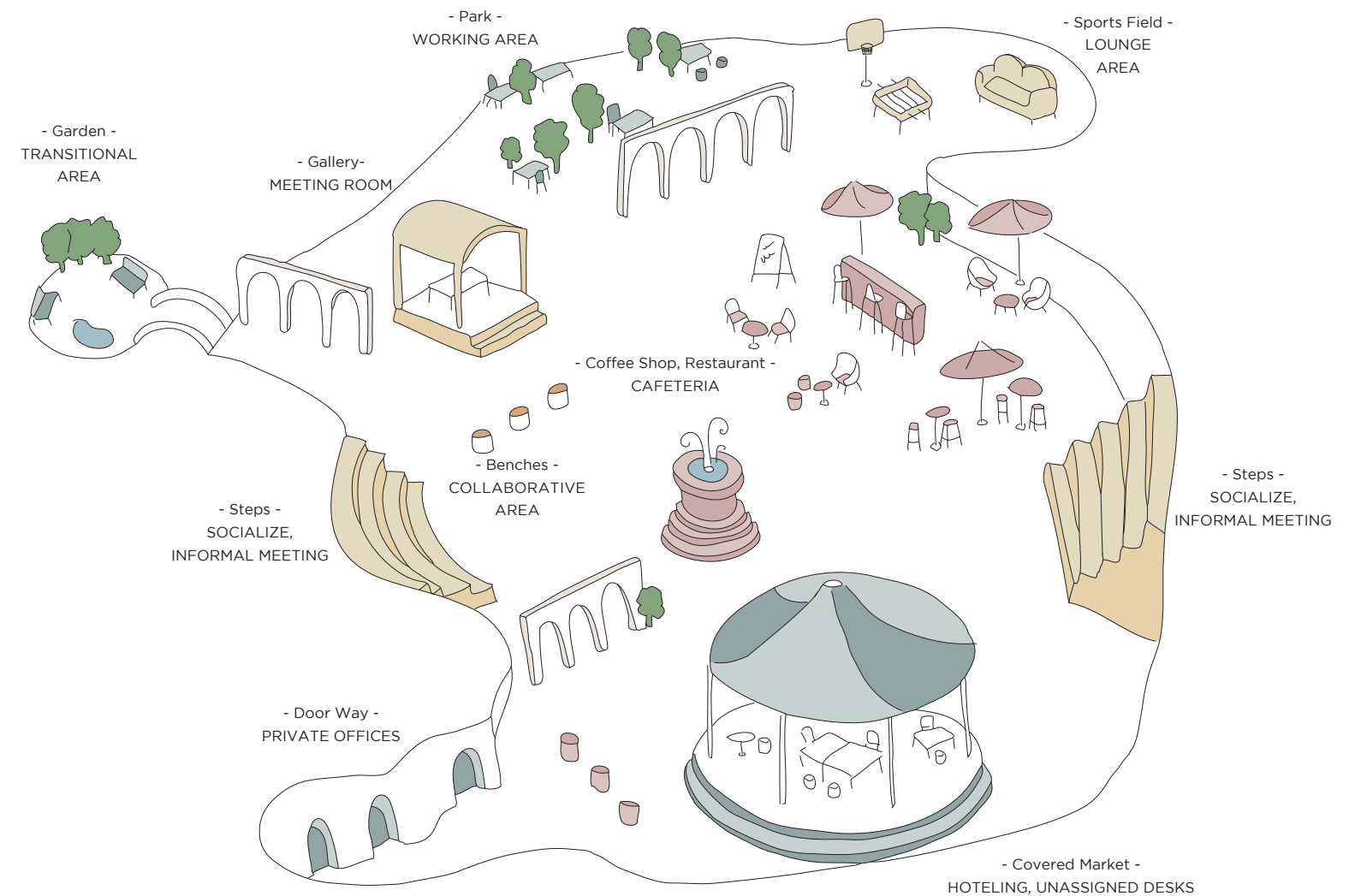

it_L'interpretazione di Martex all'evoluzione dell'ufficio, inteso come luogo di benessere sensoriale e di relazione, si ispira al concetto italiano di piazza; uno spazio ricco di diversità e stimoli sensoriali, che trasferiti nell'ambiente di lavoro consentono una sua interpretazione personale, secondo le proprie attitudini ed esigenze. La metafora urbanistica è per Martex la chiave interpretativa che meglio spiega il cambiamento che stiamo vivendo, perché la piazza è luogo d'incontro e scambio, nucleo della comunità, uno spazio complesso nel quale si innestano relazioni e in cui confluiscono i flussi principali della città, un vero incubatore di relazioni al cui centro ci sono le fonti primordiali dell'acqua (il pozzo, la fontana) e del cibo (il caffè, il chiosco, la terrazza, ecc...). Attorno alla piazza si articolano gli spazi comuni, di riposo, di ritiro e di lavoro. Come un centro urbano, l'arredo asseconda e facilita l'appropriazione dello spazio e l'aggregazione, e ci stimola nello sviluppare l'ambiente ufficio attorno ad un fulcro conviviale, che inneschi relazioni positive.

fr_L'interprétation par Martex de l'évolution du bureau, entendu comme un lieu de bien-être sensoriel et relationnel, s'inspire du concept italien de la "piazza"; un espace plein de diversité et de stimuli sensoriels, qui sont transférés à l'environnement de travail permettent une interprétation personnelle, en fonction de leurs attitudes et de leurs besoins. La métaphore urbaine est pour Martex la clé interprétative qui mieux explique le changement que nous vivons, car la place est un lieu de rencontre et d'échange, le noyau de la communauté, un espace complexe où se greffent les relations et où se rencontrent les principaux flux de la ville, véritable incubateur de relations au centre duquel se trouvent les sources primordiales d'eau (le puits, la fontaine) et d'alimentation (café, kiosque, terrasse). Tout autour de la place sont les espaces communs, les espaces de repos, de retraite et de travail. Comme un centre urbain, le mobilier soutient et facilite l'appropriation de l'espace et de l'agrégation, et nous stimule à développer l'environnement de bureau autour d'un point d'appui convivial, ce qui déclenche des relations positives.



Using “La Piazza” model in your office

en_As in a city, the square is the fulcrum of life, because it is a place of exchange and interaction, so in a company's office space it becomes fundamental having a central place where priority is teamwork, communication, ease of movement. The office layout transforms itself, no more individual stations, cubicles and few meeting rooms, but flexible spaces where people can communicate, exchange ideas, move but also work where they better perform their tasks.

it_Come in una città il fulcro della vita è la piazza, perché luogo di scambio e interazione tra le persone, così in un'azienda pensiamo diventi fondamentale organizzare al centro, un luogo che abbia come priorità il lavoro di squadra, la comunicazione, la facilità di movimento. Il layout ufficio così si trasforma; non più tante postazioni e uffici singoli, cubicle individuali e poche sale riunioni, ma spazi flessibili dove le persone possano comunicare, scambiare idee, muoversi ma anche lavorare, dove possano assolvere al meglio le proprie funzioni.

fr_Comme dans une ville, le point d'ancrage de la vie est la place, car c'est un lieu d'échange et d'interaction entre les personnes, donc dans une entreprise il devient fondamental de placer un centre au centre où la priorité est le travail d'équipe, la communication. L'agencement des bureaux se transforme ainsi, non plus autant de postes et de bureaux individuels, de cellules individuelles et de salles de réunion, mais d'espaces flexibles où les gens peuvent communiquer, échanger des idées, se déplacer mais aussi travailler.

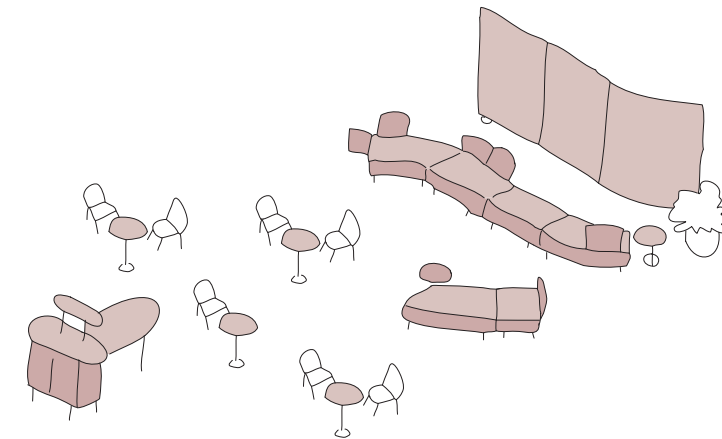
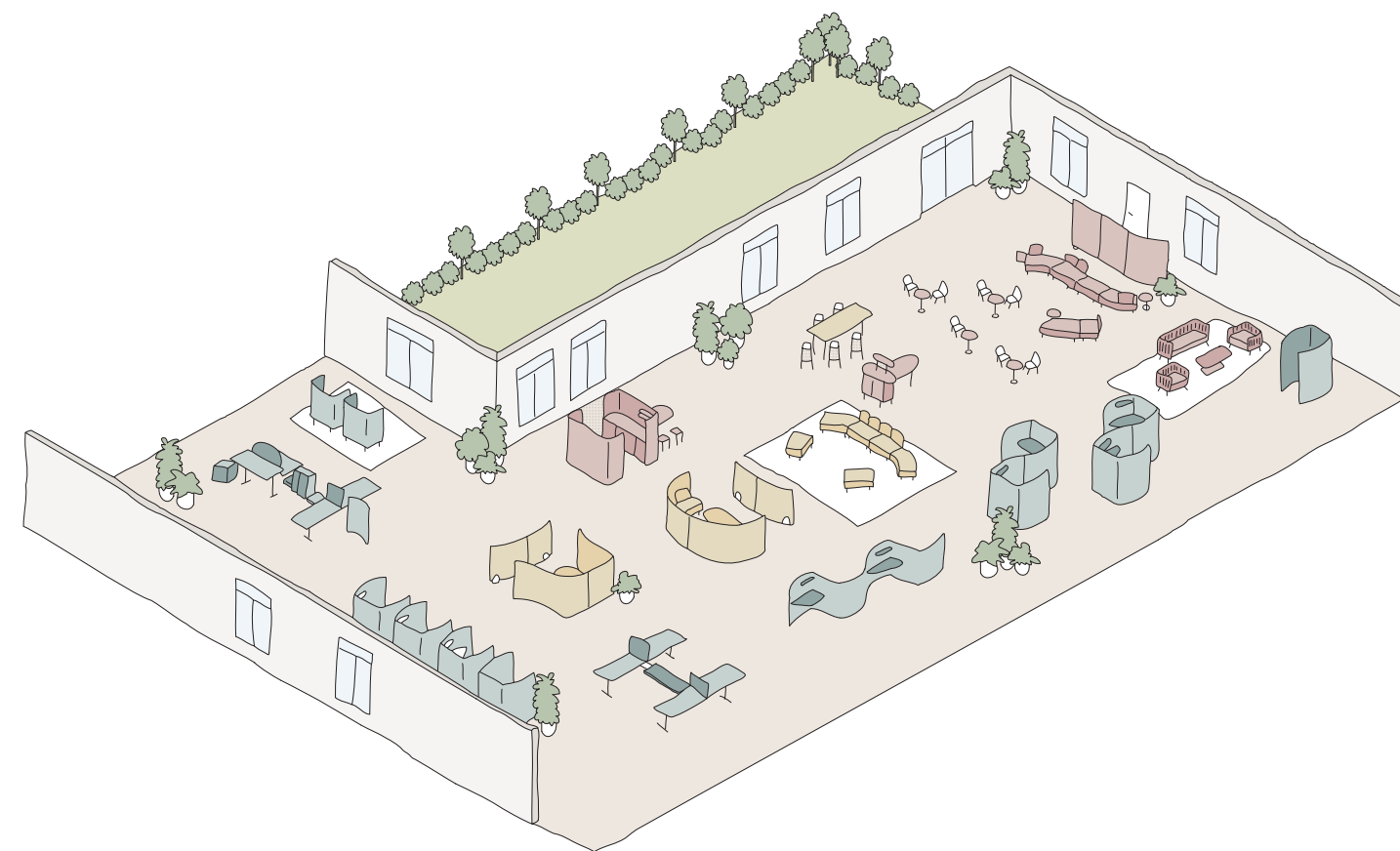

Cafeteria

en_Cafés and Bars are those unique places within a city where people choose to be. Likewise, the Cafeteria in the office space encourages people to socialize, meet, be informed and create lasting bonds.

it_I bar e le caffetterie sono rimasti i rari luoghi, all'interno delle città, che riescono ancora ad unire le persone. Nell'ufficio, l'area caffetteria permette allo stesso modo, di socializzare, incontrare, conoscere e creare legami più duraturi.

fr_Les bars et les cafés sont des endroits rares dans les villes qui peuvent unir les gens. Au bureau, l'espace cafétéria permet, de la même manière, de socialiser, rencontrer, connaître et créer des liens plus durables.

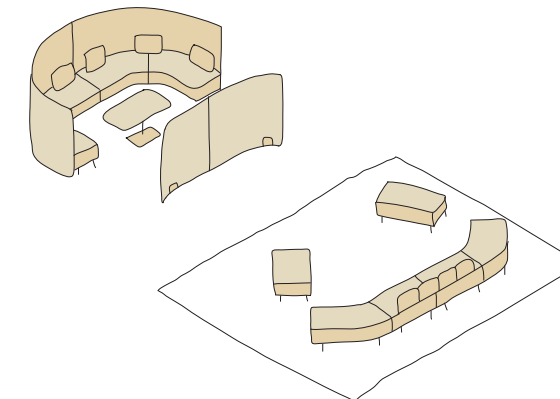

Collaborative area

en_They are common and informal areas that foster communication and interaction among people in the office allowing a free and spontaneous expression because not everything can be accomplished at each other's desk and personal enrichment comes through listening, dialogue and ideas confrontation.

it_Sono aree comuni e informali che favoriscono la comunicazione e l'interazione tra le persone in ufficio e che consentono un'espressione libera e spontanea, perché non sempre tutto avviene sopra la propria scrivania e l'arricchimento personale passa attraverso l'ascolto, il dialogo ed il confronto.

fr_Ce sont des espaces communs et informels qui favorisent la communication et l'interaction entre les personnes dans le bureau et qui permettent une expression libre et spontanée parce que tout n'est pas toujours fait sur leur bureau et l'enrichissement personnel passe par l'écoute, le dialogue et la comparaison.

Hoteling, Unassigned desks

en_The office is no longer the base of a production activity, but only one of the many places where it can be performed. Therefore, it's necessary that employees on their arrival always find a ready and functional place to concentrate and allow them to have immediate access to all the resources they need.

it_L'ufficio non è più la base dell'attività produttiva, ma solo uno dei tanti luoghi dove può essere svolta. È necessario quindi che i dipendenti al loro arrivo trovino sempre una postazione pronta e funzionale dove concentrarsi e che consenta loro di avere accesso immediato a tutte le risorse di cui necessitano.

fr_Le bureau n'est plus la base de production, mais seulement l'un des nombreux endroits où il peut être réalisé. Il est donc nécessaire que les employés à leur arrivée trouvent toujours un lieu de travail prêt et fonctionnel pour leur permettre d'accéder immédiatement à toutes les ressources dont ils ont besoin.





en_Table W. 2400 D. 800 H. 1050 mm with titanio lacquered top and natural oak legs. Nucleo stools H. 750 mm with seat in fabric Cat. H, grigio chiaro 981.

it_Tavolo L. 2400 P. 800 H. 1050 mm con piano laccato titanio e gambe rovere naturale. Sgabelli Nucleo H. 750 mm con seduta in tessuto Cat. H, grigio chiaro 981.

fr_Table L. 2400 P. 800 H. 1050 mm avec plateau laqué titanio et pieds en chêne naturel. Tabourets Nucleo H. 750 mm avec assise en tissu Cat. H, grigio chiaro 981.

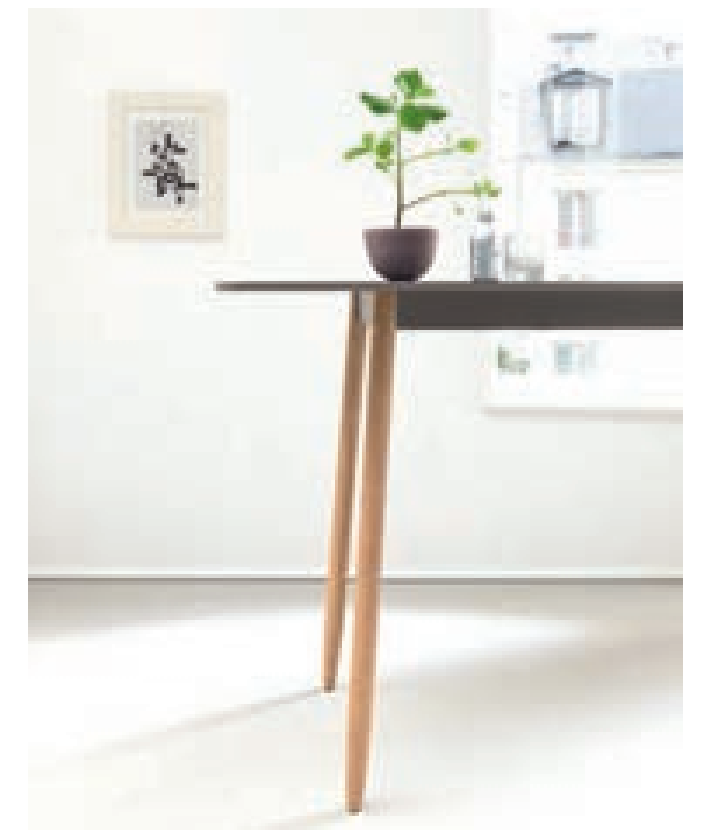



en_Freestanding composition Nucleo W. 3320 H. 1750 mm
composed by 3 panels in Cat. H fabric, grigio chiaro 981.
On the right, serpentine W. 4540 D. 600 mm with
Cat. I seat, grigio chiaro 951, feet and table in oak
finish and backs in fabric Cat. H, avio 987.

it_Composizione Nucleo freestanding L. 3320 H. 1750 mm
formata da 3 pannelli in tessuto Cat. H, grigio chiaro 981. A destra
serpentone L. 4540 P. 600 mm con seduta Cat. I, grigio chiaro 951,
piedini e tavolino rovere e schienali in tessuto Cat. H, avio 987.

fr_Composition Nucleo freestanding L. 3320 H. 1750 mm
avec trois panneaux en tissu Cat. H, grigio chiaro 981. A
droite configuration L. 4540 P. 600 mm avec chauffeuses
modulaires en tissu Cat. I, grigio chiaro 951, petits pieds et
tablette en chêne naturel et dossiers en tissu Cat. H, avio 987.





en_Nucleo single temporary work, with frontal or side tops and shelves with optional LED light.

it_Nucleo temporary work singoli, con piani frontali o laterali e mensole con luce LED opzionale.

fr_Configuration Nucleo de travail individuel temporaire avec plateaux frontaux ou latéraux et étagères en chêne naturel avec option LED.



en_Nucleo temporary work can be placed side by side to create original shapes and non-rigid layouts within the office. Nucleo temporary work is a workplace where you can take refuge to concentrate but also to share short moments.

it_Le configurazioni Nucleo temporary work possono essere accostate una accanto all'altra per creare forme originali e layout non rigidi all'interno dell'ufficio. Nucleo temporary work sono postazioni di lavoro in cui rifugiarsi per concentrarsi ma anche in cui condividere brevi momenti.

fr_Les configurations Nucleo temporary work peuvent être juxtaposés pour créer formes originales et layouts libres dans l'espace de travail ouvert. Nucleo temporary work sont de mini espaces de travail pour s'isoler et se concentrer, ou pour se rencontrer pour petites réunions.



en_Nucleo temporary work station W. 1500 D. 1435 H. 1350 mm in Cat. H fabric, grigio scuro 985 combined with edge in oak finish. Side table W. 1200 D. 690 mm in solid oak wood. Optional shelf with or without LED and undertop drawer.

it_Postazione Nucleo temporary work L. 1500 P. 1435 H. 1350 mm in tessuto Cat. H, grigio scuro 985 abbinato a bordo in finitura rovere. Piano laterale L. 1200 P. 690 mm in legno massello rovere. In opzione mensola con o senza LED e cassetto sottopiano.

fr_Configuration Nucleo temporary work L. 1500 P. 1435 H. 1350 mm avec panneaux en tissu Cat. H, grigio scuro 985 avec chants en finition chêne. Plateau latéral L. 1200 P. 690 mm en bois massif chêne. Comme option petit étagère, avec ou sans LED, et petit tiroir.



Sometimes you need to be alone: enjoy the silence!

en_Noise level in our daily life (in the workplace, city traffic, restaurants, bars, etc) are way above the limits established by regulations, causing a high level of noise pollution. And if in some cases this disturbance is now so part of our life that we hardly notice it, in many others becomes really annoying particularly when we need to focus or rest. It is said that sound is perceived as noise when it affects our well-being or mental balance. In light of this, Martex develops solutions that allow the absorption of sound waves, allowing to focus and work effectively even in environments with strong background noise.

it_I livelli di rumore presenti nella nostra vita quotidiana (negli spazi di lavoro, nel traffico cittadino, nei bar o ristoranti) sono molto alti rispetto ai limiti stabiliti e creano un elevato valore di inquinamento acustico. E se in alcuni casi questi disturbi ormai fanno così parte della nostra quotidianità che quasi non ce ne accorgiamo, altri diventano parecchio fastidiosi quando abbiamo bisogno di concentrazione o di riposo; si dice infatti che il suono sia percepito come rumore quando colpisce il nostro benessere o l'equilibrio mentale. Alla luce di questi dati Martex sviluppa soluzioni personalizzate che consentono di assorbire le onde sonore permettendo di concentrarsi e di lavorare efficacemente anche in ambienti con forte brusio.

fr_Les niveaux de bruit présents dans notre vie quotidienne (dans les espaces de travail, en ville, dans les bars ou les restaurants) sont très élevés par rapport aux limites établies, ce qui crée un niveau élevé de pollution sonore. Et si, dans certains cas, ces troubles font désormais partie de notre vie quotidienne et que nous nous en apercevons à peine, d'autres deviennent très agaçants quand nous avons besoin de concentration ou de repos; on dit que le son est perçu comme du bruit lorsqu'il affecte notre bien-être ou notre équilibre mental. À la lumière de ces données, Martex développe des solutions personnalisées qui permettent l'absorption des ondes sonores, leur permettant de se concentrer et de travailler efficacement, même dans des environnements à fort buzz.

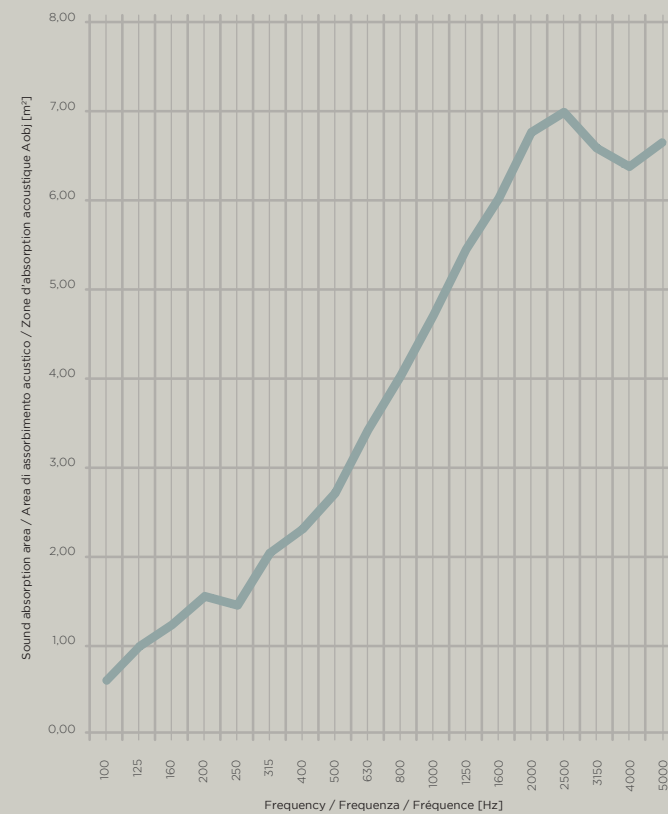

Calculation of the sound absorption area of Nucleo privacy in reverberation room according to ISO 354

Calcolo dell'area di assorbimento acustico di Nucleo privacy in camera riverberante secondo ISO 354

Calcul de la zone d'absorption acoustique Nucleo privacy en chambre riverberante selon ISO 354



en_Phone booth W. 1280 D. 1000 H. 2000 mm in Cat. I fabric, corallo 950, with top in solid oak wood. Optional socket on top, shelf with or without LEDs and bag holders.

it_Phone booth L. 1280 P. 1000 H. 2000 mm in tessuto Cat. I, corallo 950, con piano di appoggio in legno massello rovere. In opzione presa di corrente su piano, mensola con o senza LED e agganci portaborsa.

fr_Phone booth L. 1280 P. 1000 H. 2000 mm avec cloison en tissu Cat. I, corallo 950, plateau en bois massif chêne naturel. Comme option câblage pour plateau, étagère avec ou sans LED et accrochage pour sacs et manteaux.





en_Nucleo Business W. 1070 D. 650 H. 1350 mm with back in Cat. H moka 986 and Cat. I verde 957, seat and cushions in Cat. E faux-leather, testa di moro 930 and canapo 924. Feet in solid oak wood.

it_Nucleo Business L. 1070 P. 650 H.1350 mm con schienali in Cat. H, moka 986 e Cat. I, verde 957, seduta e cuscini interni in ecopelle Cat. E, testa di moro 930 e canapo 924. Piedini in legno rovere massello.

fr_Nucleo Business, chauffeuse avec dossier haut L. 1070 P. 650 H.1350 mm, dossiers en tissu Cat. H, moka 986 e Cat. I, verde 957, assise et coussins en similicuir Cat. E, testa di moro 930 et canapo 924, petit pieds en bois massif chêne naturel.



en_Dependig on the functionality request, Nucleo Business can be personalized by inserting turnable tables with a fixed tray below, in oak finish, power socket and usb for easy connection and side armrests to make this working seat even more comfortable.

it_In base alla funzionalità a cui deve rispondere, Nucleo Business si può personalizzare, inserendo tavolini girevoli con vassoio fisso sottostante in finitura rovere, prese di corrente e usb per una facile connessione e braccioli laterali per rendere ancora più confortevole questa seduta di lavoro.

fr_En base à la fonctionnalité à laquelle elle doit répondre, Nucleo Business peut être équipé avec tablettes pivotantes et bac fixe en bois massif chêne naturel, prise USB et accoudoirs pour rendre la chauffeuse encore plus confortable.

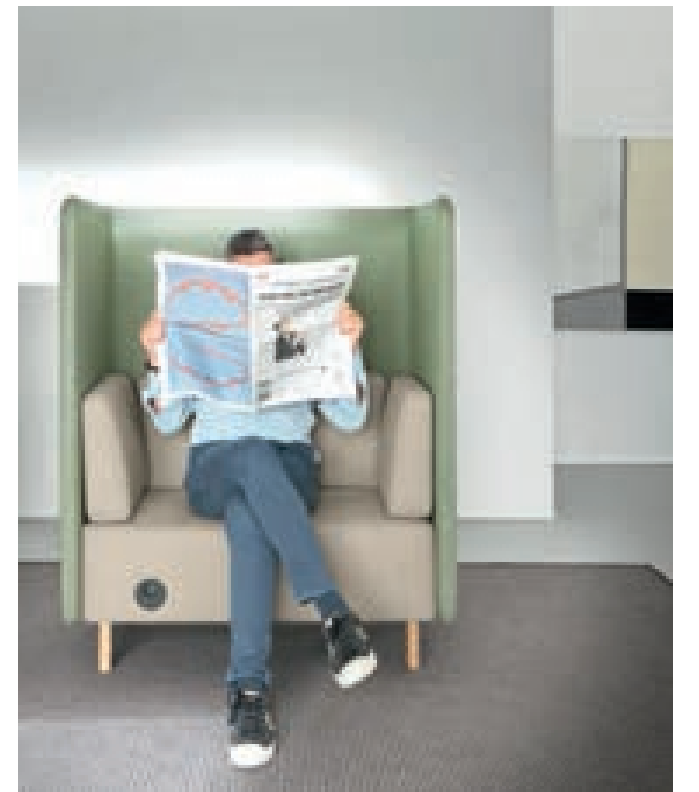

Give space to well-being in the office

en_To give their best in the office, people need to feel good, be motivated, engaged and involved. Martex thinks the office should be designed with places that meet these needs and allow people to concentrate, communicate and collaborate. Spaces are less and less assigned to individuals but increasingly shared. It is precisely the possibility of choosing one's place in the company that creates well-being in the office.

it_Per dare il massimo in ufficio, le persone devono sentirsi bene, essere motivate, stimolate e coinvolte. Martex interpreta l'ufficio come luogo che soddisfi questi bisogni e che permetta alle persone di concentrarsi, comunicare, collaborare. Gli spazi sono sempre meno assegnati alle singole persone e sempre più in condivisione. È proprio la possibilità di scegliere il proprio posto in azienda che crea benessere in ufficio.

fr_Pour donner le meilleur au bureau, les gens doivent se sentir bien, être motivés, stimulés et impliqués. Le bureau doit être conçu avec des endroits qui répondent à ces besoins et permettre aux gens de se concentrer, de communiquer et de collaborer. Les espaces sont de moins en moins assignés aux individus et de plus en plus partagés. C'est précisément la possibilité de choisir sa place dans l'entreprise qui crée le bien-être au bureau.

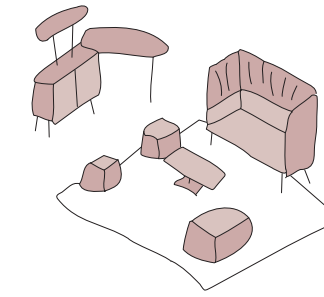

Cafeteria

en_It is a cosy and comfortable space where people can feel at ease, relax, communicate and build relationships between colleagues, during a coffee break.

it_È uno spazio comodo e confortevole in cui le persone possono sentirsi a proprio agio, rilassarsi, comunicare e costruire rapporti tra colleghi, nei momenti di pausa.

fr_C'est un espace cosy et confortable où les gens peuvent se sentir à l'aise, se détendre, communiquer et établir des relations entre collègues, dans des moments de pause.

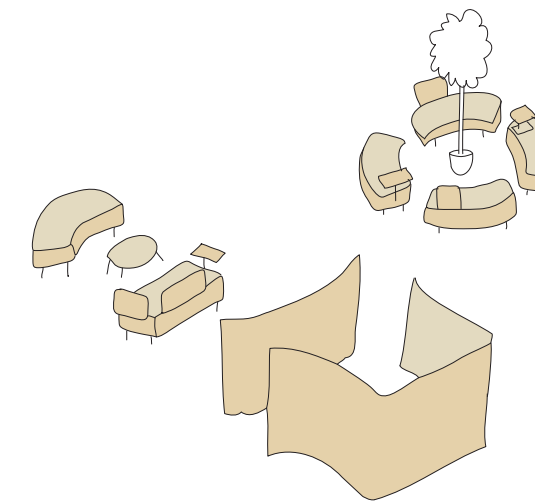

Collaborative area

en_Teamwork encourages creativity, fosters acquaintance and cultural exchange; places dedicated to informal meetings encourage collaboration and interaction to share and transfer knowledge.

it_Il lavoro in team incentiva la creatività, favorisce conoscenze e scambio culturale; luoghi dedicati a incontri informali incoraggiano la collaborazione e l'interazione per condividere e trasferire la conoscenza.

fr_Le travail d'équipe stimule la créativité, favorise la connaissance et l'échange culturel; les lieux dédiés aux réunions informelles encouragent la collaboration et l'interaction pour partager et transférer les connaissances.

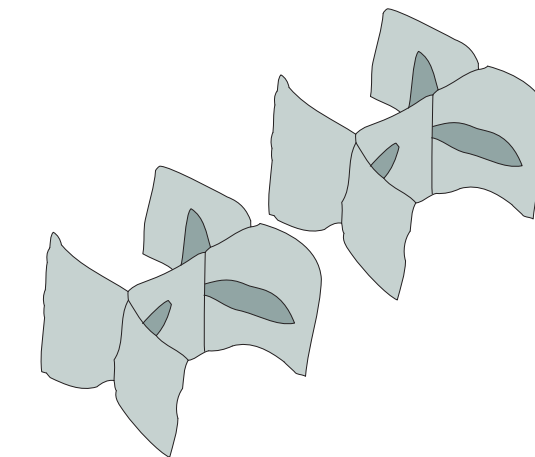

Hoteling, Unassigned desks

en_In the office, the so-called "nomads", people who move from place to place to work, need high-performance workstations to ensure their fast connections. The desk is no longer a physical space but a real worktool.

it_In ufficio, i cosiddetti "nomadi", persone che si spostano da un luogo all'altro per lavorare, hanno bisogno di postazioni performanti che garantiscano loro connessioni veloci. La scrivania non è più uno spazio fisico ma un vero e proprio strumento di lavoro.

fr_Au bureau, les soi-disant "nomades", personnes qui se déplacent d'un endroit à un autre pour travailler, ont besoin de postes performants qui garantissent des connexions rapides. Le bureau n'est plus un espace physique mais un véritable outil de travail.







en_Nucleo pouf can be enriched and evolved in an elegant daybed, or in a comfortable sofa with fixed table; it only depends on how we want to play with backrest, armrests and tables.

it_Nucleo pouf può essere arricchito con accessori trasformandosi in un'elegante dormeuse, oppure in un comodo divanetto con tavolino fisso agganciato; dipende solo da come vogliamo giocare con braccioli, schienali e tavolini.

fr_Nucleo pouf peut être enrichi par accessoires pour se transformer dans une dormeuse élégante, ou dans un confortable canapé avec tablette fixe accrochée; ça dépend seulement comme nous voulons jouer avec accoudoirs, dossiers et tablettes.



Flexibility is a must. Well, so we can make you work wherever you choose



en_New technologies have revolutionized ways, times and places of work, leaving people free to carry out their activities as they see fit and to work wherever there is the possibility of connecting. The office has thus become no longer a static place that requires desks and assigned seats, but increasingly a place for sharing and socializing, where barriers no longer exist and where relationships create new ideas and stimuli, fueling people's efficiency. Workers who claim to be able to move to different areas of the office while they work are 1.3 times more likely to be involved than other employees; those who have a space that helps them to relate to their colleagues, is 1.5 times more likely to engage with the company and produce more ("State of the American Workplace", Gallup, 2017). People look for a sense of ownership and privacy but still want interactions with others. Connectivity and flexibility, but above all this new generational approach, seem to be the key words for a correct design of work spaces. The modular collection Nucleo can be configured, modified and implemented at any time offering uncountable combinations and always adapting to the needs of a work in progress, simple poufs can replace the desk and become comfortable and informal work areas.

it_Le nuove tecnologie hanno rivoluzionato modalità, tempi e luoghi di lavoro, lasciando l'uomo libero di svolgere le proprie attività come ritiene più opportuno e di lavorare ovunque ci sia la possibilità di connettersi. L'ufficio è così diventato, non più un luogo statico che necessita di scrivanie e posti assegnati, ma sempre di più un luogo di condivisione e socializzazione, dove non esistono più barriere e in cui le relazioni creano nuovi stimoli ed idee, alimentando l'efficienza delle persone. I lavoratori che affermano di potersi spostare in aree diverse dell'ufficio mentre lavorano hanno 1,3 volte più probabilità di sentirsi coinvolti rispetto ad altri dipendenti; chi dispone di uno spazio che li aiuta a relazionarsi con i colleghi, ha 1,5 volte più probabilità di legarsi all'azienda e produrre di più ("State of the American Workplace", Gallup, 2017). Le persone cercano un senso di proprietà e privacy ma desiderano comunque interazioni con gli altri. Connettività e flessibilità, ma soprattutto questo nuovo approccio generazionale, sembrano essere diventate le parole chiave per una corretta progettazione degli spazi di lavoro. La collezione Nucleo essendo modulare può essere configurata, modificata ed implementata in qualsiasi momento offrendo innumerevoli combinazioni e adattandosi sempre alle esigenze di un lavoro in evoluzione; semplici pouf posso sostituire le scrivanie diventando confortevoli e informali aree di lavoro.

fr_Les nouvelles technologies ont révolutionné les manières, les temps et les lieux de travail, laissant à l'homme la liberté d'exercer ses activités à sa guise et de travailler partout où il est possible de se connecter. Le bureau est ainsi devenu, non plus un lieu statique exigeant des bureaux et des places assignées, mais de plus en plus un lieu de partage et de socialisation, où il n'y a plus d'obstacles et où les relations créent de nouveaux stimuli et idées, alimentant le l'efficacité des personnes. Les travailleurs qui prétendent être en mesure de déménager dans différentes zones du bureau pendant qu'ils travaillent sont 1,3 fois plus susceptibles d'être impliqués que les autres employés; ceux qui ont un espace qui les aide à se rapprocher de leurs collègues, sont 1,5 fois plus susceptibles de se lier à l'entreprise et de produire plus ("État du lieu de travail américain", Gallup, 2017). Les gens cherchent un sentiment de propriété et de confidentialité, mais veulent toujours des interactions avec les autres. La connectivité et la flexibilité, mais surtout cette nouvelle approche générationnelle, semblent être les maîtres mots pour une conception correcte des espaces de travail. La collection Nucleo étant modulable peut être configurée, modifiée et mise en œuvre à tout moment offrant d'innombrables combinaisons et s'adaptant toujours aux besoins d'un travail en évolution, de simples poufs peuvent remplacer les bureaux pour devenir des espaces de travail confortables et informels.





en_From serpentine to single poufs thanks to a simple gesture. The hooking brackets are always present in the poufs and allow easy reconfigurability of the product. Seats in Cat. H fabric, grigio scuro 895 and Cat. I backrest, grigio chiaro 954.

it_Da serpentine a pouf singoli grazie ad un semplice gesto. Le staffe di aggancio sono sempre presenti nei pouf e permettono una facile riconfigurabilità del prodotto. Seduta in tessuto Cat. H, grigio scuro 895 e schienale Cat. I, grigio scuro 954.

fr_D'une forme à serpentine aux poufs individuels grâce uniquement à un simple geste. Les crochets de liaison sont toujours présents dans les poufs et ils permettent une modularité facile du produit. Assise en tissu Cat. H, grigio scuro 895 et dossier Cat. I, grigio scuro 954.





en_As can be seen on the right detail, all Nucleo panels can be double-sided and have different fabrics between sides; in this case, for example, external fabric Cat. H, moka 986 and internal fabric Cat. I, grigio chiaro 951.

it_Come si nota nel particolare qui a destra, tutti i pannelli Nucleo possono essere bifacciali ed avere tessuti diversi tra i due lati; in questo caso ad esempio, tessuto esterno Cat. H, moka 986 e tessuto interno Cat. I, grigio chiaro 951.

fr_Comme on remarque dans le détail à droite, tous les panneaux Nucleo peuvent avoir tissus différents dans les deux côtés; dans la photo par exemple tissu extérieur Cat. H, moka 986 et tissu intérieur Cat. I, grigio chiaro 951.





en_Nucleo Meeting W. 2170 D. 2000 H. 1350 mm with W. 1400 D. 700 H. 750 mm table in solid oak. Panels in fabric Cat. H, verde 983, seat in Cat. I, verde 957 and cushions in Cat. H, panna 984.

it_Nucleo Meeting L. 2170 P. 2000 H. 1350 mm con piano L. 1400 P. 700 H. 750 mm in rovere massello. Pannelli in tessuto Cat. H, verde 983, seduta in Cat. I, verde 957 e cuscini in Cat. H, panna 984.

fr_Nucleo Meeting, composition réunion L. 2170 P. 2000 H. 1350 mm avec plateau L. 1400 P. 700 H. 750 mm en chêne naturel massif. Panneaux en tissu Cat. H, verde 983, canapés avec assise en tissu Cat. I, verde 957 et coussins en tissu Cat. H, panna 984.

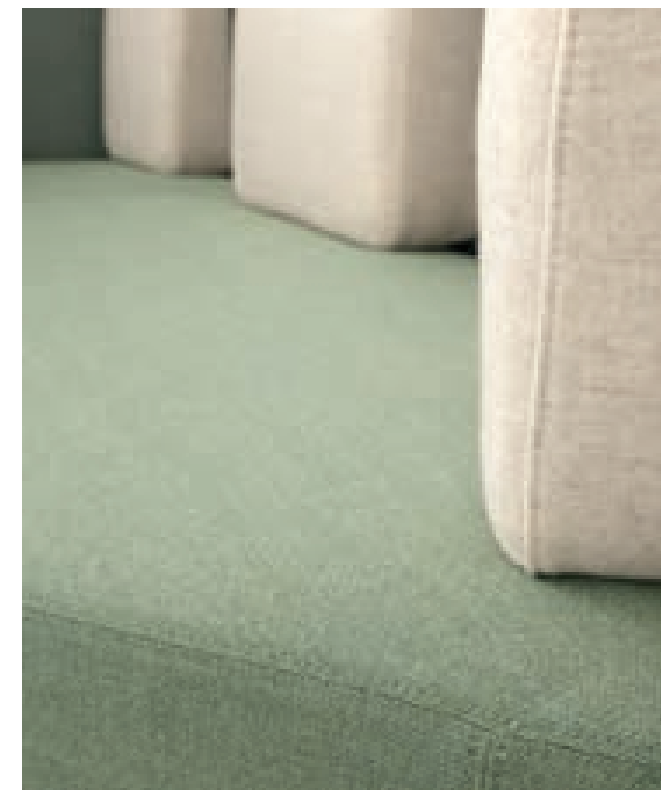

en_Nucleo perfectly matches with the soft lines of Inattesa, which is now also proposed in smooth back version. The round lines of the Nucleo panels and Inattesa create a situation of comfort and visual well-being that are indispensable in the new office layouts.

it_Nucleo si abbina perfettamente alle linee morbide di Inattesa, ora proposta anche nella versione con schienale liscio. Le linee curve dei pannelli Nucleo e di Inattesa creano una situazione di comfort e benessere visivo indispensabili nei nuovi layout ufficio.

fr_La collection Nucleo est parfaite avec les lignes douces d'Inattesa, maintenant proposée aussi dans la version avec dossier lisse. Les lignes courbes des panneaux Nucleo et d'Inattesa créent cette situation de confort et bien-être visuel indispensable dans les nouvelles typologies d'espace bureau.



en_Nucleo Waiting W. 2570 D. 2000 H. 1350 mm.
Panels in fabric Cat. H, verde 983, seat in Cat. I verde 957 and cushions in Cat. H, 984 panna. Coffee table with solid oak top H. 1200 D. 600 mm.

it_Nucleo Waiting L. 2570 P. 2000 H. 1350 mm.
Pannelli in tessuto Cat. H, verde 983, seduta in Cat. I verde 957 e cuscini in Cat. H, 984 panna. Tavolino con piano in rovere massello L. 1200 P. 600 mm.

fr_Nucleo Waiting, composition attente L. 2570 P. 2000 H. 1350 mm. Panneaux en tissu Cat. H, verde 983, assise en tissu Cat. I, verde 957 et coussins en tissu Cat. H, 984 panna. Table basse avec plateaux L. 1200 P. 600 mm en chêne naturel massif.

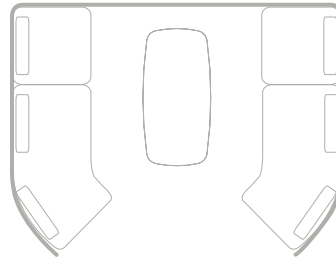

en_Nucleo Meeting W. 2170 D. 2000 H. 1350 mm.
Panels in fabric Cat. H, verde 983. Hooked table W. 1400 D. 700 mm in solid oak with cable port in top finish. Nucleo seat with white lacquered seat.

it_Nucleo Meeting L. 2170 P. 2000 H. 1350 mm.
Pannelli in tessuto Cat. H, verde 983. Tavolo agganciato L. 1400 P. 700 mm in rovere massello con passacavo in finitura. Sedute Nucleo con scocca laccata bianca.

fr_Nucleo Meeting, composition réunion L. 2170 P. 2000 H. 1350 mm. Panneaux en tissu Cat. H, verde 983, assise en tissu Cat. I verde 957. Table accroché avec plateaux L. 1400 P. 700 mm en chêne naturel massif. Chaises Nucleo avec coque laquée blanche.

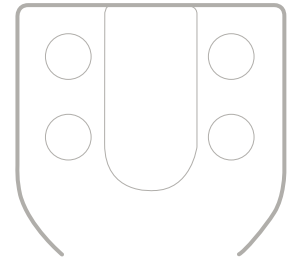





en_Inattesa Sofa W. 1650 D. 690 H. 1350 mm,
backrest in Cat. A fabric grigio scuro 885 and
interne in Cat. H fabric grigio chiaro 981.

it_Divanetto Inattesa L. 1650 P. 690 H. 1350 mm,
schienali in tessuto Cat. A, grigio scuro 885 e
interno in tessuto Cat. H, grigio chiaro 981.

fr_Canapé Inattesa L. 1650 P. 690 H. 1350 mm
avec dossier haut en tissu Cat. A, grigio scuro
885, assise et coussins en tissu Cat. H, grigio
chiaro 981.



Coffee break as well as lunch time, are moments to share with colleagues

“Sharing a meal is much more intimate activity than looking at an Excel chart together”

Attention to the person is also realized through food, as a fulcrum of relationship and well-being. An increasing percentage of workers usually consume their lunch in front of the PC, while working, reading the news or chatting; this attitude, practically disinterested in food, can undermine all the purpose for a healthy and balanced diet. In fact, it has been proved that an improper diet at work can not only increase body weight, but can potentially reduce productivity by up to 20%. A proper diet, on the contrary, would reduce sick days and even injuries. Furthermore, a study carried out by Cornell University in Ithaca states that food is a natural social link. “Sharing a meal is a much more intimate activity than looking at an Excel chart together and that intimacy translates into the effectiveness of teamwork”. Eat together with your colleagues gives people the opportunity to get to know each other, strengthen relationships and double the cooperation among employees. It would be great if all these aspects could be taken into consideration by companies during the design phase or reconfiguration of an office space by adopting in central office locations cafeterias and dining areas no longer relegated. Martex deals with the theme of Social Eating with dedicated elements that respond perfectly to these needs with the aim of increasing business performance by creating strong bonds between people.

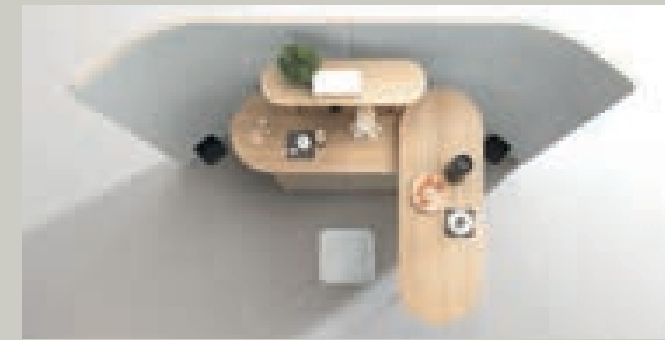

L'attention à la personne est également réalisée par la nourriture, en tant que point d'appui de la relation et du bien-être. Un pourcentage croissant de travailleurs consomment habituellement le déjeuner devant le PC, travaillant, lisant des nouvelles ou bavardant, et ce comportement peut contrecarrer toutes les bonnes intentions d'une saine alimentation. En fait, il a été démontré qu'un régime alimentaire défavorable sur le lieu de travail peut non seulement augmenter le poids, mais aussi diminuer la productivité jusqu'à 20%. Une bonne alimentation, au contraire, réduirait les jours de maladie et même les blessures. En outre, une étude réalisée par l'Université Cornell affirme que la nourriture est une colle sociale naturelle. “Partage d'un repas est une activité beaucoup plus intime que de regarder un tableau Excel ensemble et que l'intimité se traduit par l'efficacité du travail d'équipe”. Manger ensemble avec les autres donne aux gens l'occasion de se connaître, de renforcer les relations et de doubler la coopération entre les employés. Tous ces aspects doivent donc être pris en compte par les entreprises en phase de conception ou de reconfiguration de l'agencement des bureaux, réalisant en leur sein, dans les zones centrales et non plus reléguées, les espaces bar, cafétéria ou lieux dédiés au partage d'aliments sains. Martex traite le thème de l'alimentation sociale avec des éléments dédiés qui répondent parfaitement à ces besoins avec le fin de l'augmentation de la performance des entreprises en créant des liens solides entre les gens.

L'attenzione alla persona si realizza anche attraverso il cibo, come fulcro di relazione e di benessere. Una percentuale sempre maggiore di lavoratori è solita consumare il pranzo davanti al pc, lavorando, leggendo news, o chattando e questo comportamento può vanificare tutti i buoni propositi di una dieta sana. È stato infatti dimostrato che, un regime alimentare scorretto sul luogo di lavoro, non solo può portare ad un aumento del peso corporeo, ma anche diminuire la produttività fino al 20%. Una giusta alimentazione, al contrario, ridurrebbe giorni di malattia e addirittura infortuni. Inoltre uno studio effettuato dalla Cornell University afferma che il cibo sarebbe un collante sociale naturale. “Condividere un pasto è un'attività molto più intima del fatto di guardare insieme una tabella Excel e quell'intimità si traduce nell'efficacia del lavoro di squadra”. Mangiare insieme agli altri dà la possibilità alle persone di conoscersi, rafforzare i rapporti fino a raddoppiare la cooperazione tra i dipendenti. Tutti questi aspetti andrebbero quindi tenuti in considerazione dalle aziende in fase di progettazione o di riconfigurazione del layout degli uffici, realizzando al loro interno, in zone centrali e non più relegate, delle aree bar, caffetteria o luoghi dedicati alla condivisione di cibo sano. Martex affronta il tema di Social Eating con elementi dedicati che rispondono perfettamente a queste esigenze con l'obiettivo di aumentare le performance aziendali creando solidi legami tra le persone.





en_Nucleo Pantry is a service cabinet designed to furnish break areas but also to be inserted in elegant meeting rooms. It has been designed to support and contain equipment for the preparation of coffee and drinks but also to accommodate tables H. 750 or H. 1050 mm suitable for sharing moments of relaxation.

It_Nucleo Pantry è un mobile di servizio pensato per arredare aree break ma anche per essere inserita in eleganti sale riunioni. È stata progettata per supportare e contenere attrezzature per la preparazione di caffè e bevande ma anche per accogliere tavoli H. 750 o H. 1050 mm ideali nella condivisione dei momenti di relax.

fr_Nucleo Pantry est un meuble de service pensé pour aménager zones break et attente mais aussi salles de réunion. Elle a été projetée pour soutenir et contenir équipements pour la préparation de café et boissons mais aussi pour accueillir tables H. 750 ou H. 1050 mm idéaux pour partager moments de relax.



en_Nucleo Corner W. 1900 D. 650
H. 1750 mm in fabric Cat. I, grigio
scuro 954. Table with solid oak top
W. 1400 D. 700 H. 1050 mm.

it_Nucleo Corner L. 1900 P. 650
H. 1750 mm in tessuto Cat. I, grigio
scuro 954. Tavolo con piano rovere
massello L. 1400 P. 700 H. 1050 mm.

fr_Nucleo Corner, cloison L. 1900
P. 650 H. 1750 mm en tissu Cat.
I, grigio scuro 954. Table haut
L. 1400 P. 700 H. 1050 mm accroché
en chêne naturel massif.



en_Nucleo Corner is composed by Galaxy cabinets in different sizes W. 900, 1350 or 1800 mm in different melamine and lacquered finishes. It is possible to hook on it tables in different heights.

it_Nucleo Corner è composto da contenitori Galaxy in diverse dimensioni L. 900, 1350 o 1800 mm, in diverse finiture melaminiche e laccate. È possibile agganciarvi tavoli in diverse altezze.

fr_Nucleo Corner est un système composé par armoires Galaxy de différents largeurs (900, 1350 ou 1800 mm) avec finitions mélamine et laque différentes. Possibilité d'accrocher tables de différentes hauteurs.



We have a green soul and we transfer it to our products

“The sustainability of raw materials supply chain, the ethical choice of suppliers and process with low environmental impact are the main theme for the development of each of our individual products”



it_Traduciamo il rispetto per la natura e per l'ambiente che ci circonda in azioni concrete, utilizzando lavorazioni a minor impatto ambientale e privilegiando l'utilizzo di materiali naturali, riciclabili e provenienti da colture controllate e certificate.

Il conglomerato ligneo che viene impiegato per la produzione dei pannelli, rientra nella classe CARB P2 e soddisfa gli standard per le emissioni ANSI / BIFMA come stabilito dalla certificazione LEED rispetto al credito IEQ4.5 (funzionale a garantire la bassa concentrazione di composti organici volatili VOCs). Sviluppiamo e produciamo prodotti durevoli e che possano garantire un lungo ciclo di vita, o packaging compatti e leggeri per limitare l'impatto del trasporto. Investiamo risorse perchè tutta la nostra filiera industriale sia premiante ed attenta a questi valori. Martex ha certificato il suo processo di qualità, in accordo lo standard UNI EN ISO 9001.

fr_Nous traduisons le respect de la nature et de l'environnement qui nous entoure par des actions concrètes, en utilisant des procédés ayant un impact environnemental moindre et en favorisant l'utilisation de matériaux naturels et recyclables provenant de cultures contrôlées et certifiées. Le conglomerat de bois utilisé pour la fabrication des panneaux relève de la classe CARB P2 et répond aux normes ANSI / BIFMA telles qu'établies par la certification LEED par rapport au crédit IEQ4.5 (fonctionnel pour garantir la faible concentration en composés organiques volatils COV). Nous développons et produisons des produits durables qui peuvent garantir un cycle de vie long, ou des emballages compacts et légers pour limiter l'impact du transport. Nous investissons des ressources parce que toute notre chaîne d'approvisionnement industrielle est enrichissante et attentive à ces valeurs. Martex a certifié son processus de qualité, conformément à la norme UNI EN ISO 9001.

en_We translate respect for nature and for environment that surrounds us by concrete actions, using processes with a lower environmental impact and favoring the use of natural, recyclable materials from controlled and certified crops. The wood conglomerate that is used for the production of the panels, falls within the class CARB P2 and meets the standards for the ANSI / BIFMA emissions as established by the LEED certification compared to the credit IEQ4.5 (functional to guarantee the low concentration of volatile organic compounds VOCs). We develop and produce durable products that can guarantee a long life cycle, or compact and lightweight packaging to limit the impact of transport. We invest resources because all our industrial supply chain is rewarding and attentive to these values. Martex has certified its quality process, in accordance with the UNI EN ISO 9001 standard.

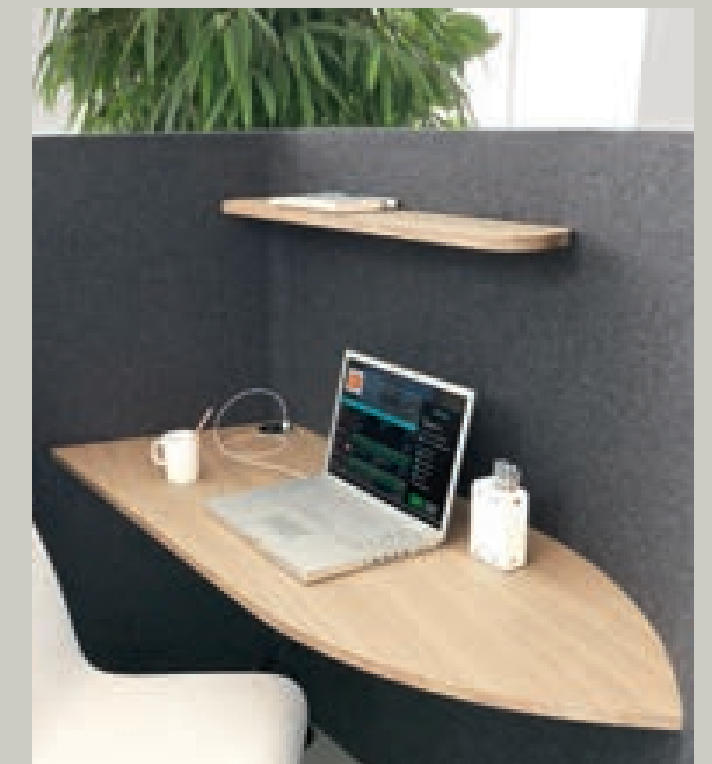

Suggestions

An office designed just for you

en_Our history, knowledge of the territory and a consolidated supply chain of trusted partners allows us to customize the products according to the requests of designers and architects who are looking for an increasingly flexible, versatile and reliable company on the market. The chart of the products listed below in the technical part presents the standard articles developed by us, designed and delivered with standard lead times; however, they represent a starting point for creative and personalized solutions.

it_La nostra storia, la conoscenza del territorio e una filiera consolidata di partner fidati, ci permette di personalizzare i prodotti in base alle richieste di progettisti e architetti che cercano nel mercato, un'azienda sempre più flessibile, versatile e affidabile. L'abaco dei prodotti qui di seguito riportati nella parte tecnica, presenta gli articoli di serie da noi sviluppati, progettati e consegnati con tempi di consegna standard; rappresentano però un punto di partenza per soluzioni creative e personalizzate.

fr_Notre histoire, notre connaissance du territoire et une chaîne d'approvisionnement consolidée de partenaires de confiance nous permettent de personnaliser les produits en fonction des demandes des designers et des architectes à la recherche d'une entreprise de plus en plus flexible, polyvalente et fiable sur le marché. L'abaque des produits énumérés ci dessous dans la partie technique présente les articles standard développés par nous, conçus et livrés avec des délais de livraison standard; cependant, ils représentent un point de départ pour des solutions créatives et personnalisées.

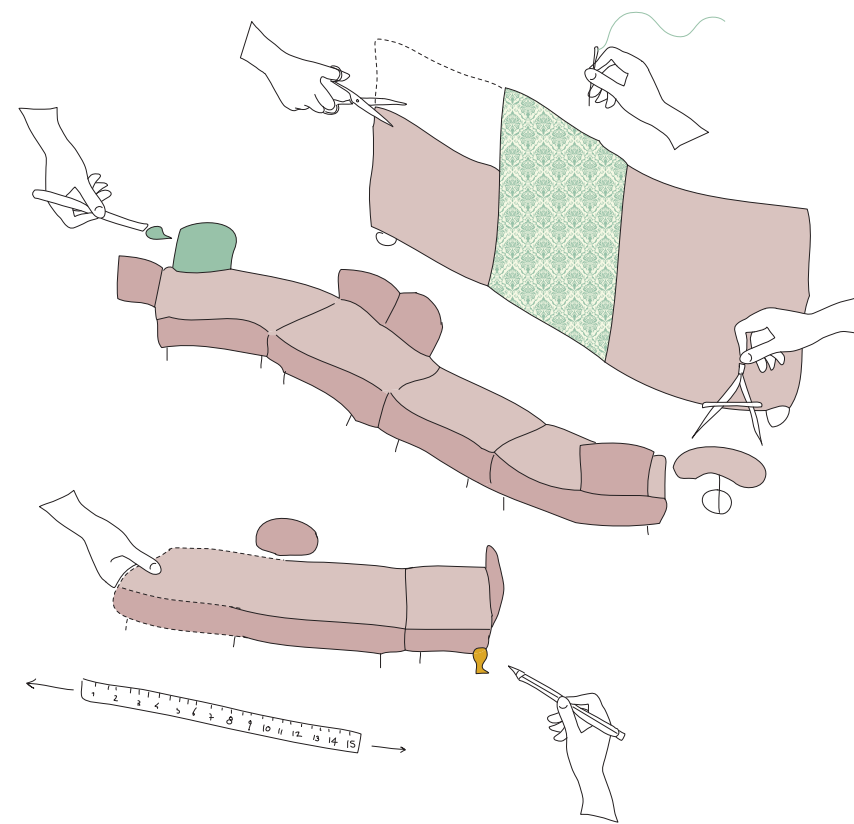

“The only man I know who behaves sensibly is my tailor; he takes my measurements a new each time he sees me. The rest go on with their old measurements and expect me to fit them”

(George Bernard Shaw)







en_These images represent some inspirations of how Martex can customize Nucleo with edges and fabrics not in the range. Our project managers will help you find the right combination of finishes for your project.

it_Queste immagini rappresentano alcune ispirazioni di come Martex può personalizzare Nucleo con bordi e tessuti non in gamma. I nostri project manager vi aiuteranno a trovare la giusta combinazione di finiture per il vostro progetto.

fr_Ces images représentent quelques inspirations de comme Martex peut personnaliser Nucleo avec chants et tissu hors collection. Nos project managers vous aideront à trouver la combinaison juste de finitions pour vos projets.



From standard to custom.
Make your product unique



Specs sheets

Nucleo pouf

en_It is a modular upholstered system, which can be reconfigured at any time and it is presented both with individual elements and with articulated compositions, where shapes and colors play a decisive role. They are also customizable with movable laptop tops or fixed tables and plug-in sockets with integrated USB.

it_È un sistema di imbottiti modulari, riconfigurabile in qualsiasi momento. Essi si esprimono sia con elementi singoli che con composizioni articolate, dove forma e colori giocano un ruolo determinante. Sono inoltre personalizzabili con piani per laptop mobili o tavolini fissi e prese plug-in con USB integrati.

fr_Système modulaire de poufs qui peut être reconfiguré à tout moment. Ils s'expriment soit avec des éléments individuels que avec des compositions articulées, où la forme et les couleurs jouent un rôle décisif. Ils sont également personnalisables avec tablettes pivotantes ou fixes et prises avec USB intégré.

Pouf / Pouf / Pouf H. 430 mm - 17"

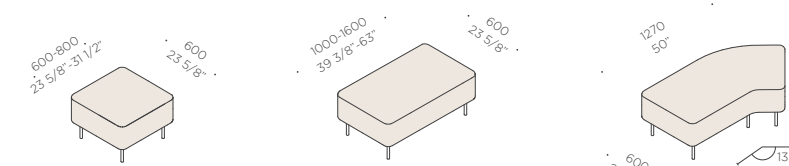

Pouf fixing / Fissaggio pouf / Liaison pouf



en_Every pouf is always equipped with hooks to be reconfigurable
it_Ogni pouf è sempre dotato di agganci per essere riconfigurabile
fr_Chaque pouf est équipé de pièces de liaison pour être toujours reconfigurable

Accessories / Accessori / Accessoires

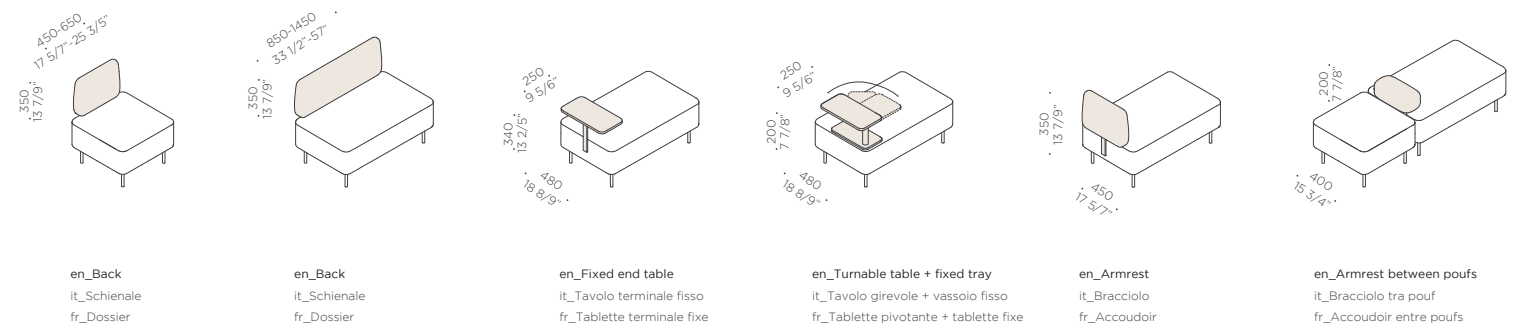

Options / Opzioni / Options



en_Black metal structure
it_Struttura metallo nero
fr_Structure en métal noir



en_Wooden structure
it_Struttura legno
fr_Structure en bois

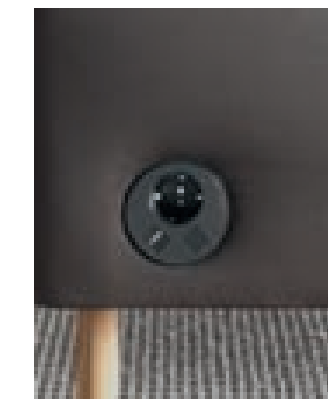

en_Cable management, custom power module
it_Elettrificazione, a richiesta diverse prese di corrente
fr_Électrification, sur demande différentes prises



Nucleo armchair & sofa

en_It is a modular armchair and sofas system that can be personalized by integrated power and Usb chargers and tables.

it_È un sistema di poltrone e divani componibili. Sono personalizzabili con prese plug in con USB integrati o tavolini.

fr_Système de fauteuils et canapés modulaires. Ils peuvent être personnalisés avec prises avec USB intégré ou tablettes.

Armchair / Poltrona / Fauteuil

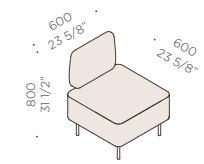

en_Armchair with back
it_Poltrona con schienale
fr_Fauteuil avec dossier

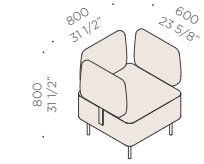

en_Armchair with armrests
it_Poltrona con braccioli
fr_Fauteuil avec accoudoirs

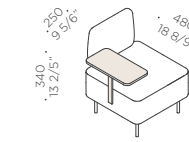

en_Fixed end table
it_Tavolo terminale fisso
fr_Tablette terminale fixe

Accessories / Accessori / Accessoires

Sofa / Divano / Canapé

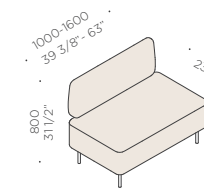

en_Sofa with back
it_Divano con schienale
fr_Canapé avec dossier

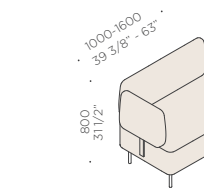

en_Sofa with armrests
it_Divano con braccioli
fr_Canapé avec accoudoirs

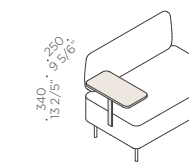

en_Fixed end table
it_Tavolo terminale fisso
fr_Tablette terminale fixe

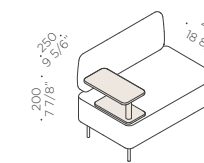

en_Turnable table + tray
it_Tavolo girevole + vassoio
fr_Tablette pivotante + tablette fixe

Accessories / Accessori / Accessoires

Options / Opzioni / Options



en_Black metal structure
it_Struttura metallo nero
fr_Structure en métal noir



en_Wooden structure
it_Struttura legno
fr_Structure en bois

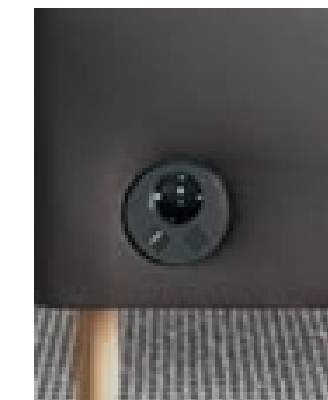

en_Cable management, custom power module
it_Elettrificazione, a richiesta diverse prese di corrente
fr_Electrification, sur demande différentes prises



Nucleo Business

en_Thanks to the high back and the configuration with tables and electrification, the Business armchair is ideal in lounge areas or in open space when you need privacy in comfortable work or relax areas.

it_Grazie allo schienale alto e alla configurazione con tavolini ed elettrificazione, la poltrona Business è ideale in aree lounge o in open space quando si necessita di privacy in confortevoli aree di lavoro o relax.

fr_Grâce au dossier haut et à la configuration avec tablette et électrification, la fauteuil Business est idéal dans les zones d'attente ou dans les espaces ouverts quand vous avez besoin d'intimité et confort pour travailler ou se relaxer.

Armchair / Poltrona / Fauteuil

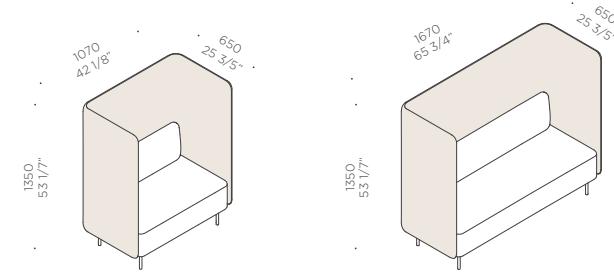

Accessories / Accessori / Accessoires



en_Armrest
it_Bracciolo
fr_Accoudoir

en_Tunable table + tray
it_Tavolo girevole + vassoio
fr_Tablette pivotante + tablette fixe

Options / Opzioni / Options



en_Black metal structure
it_Struttura metallo nero
fr_Structure en métal noir



en_Wooden structure
it_Struttura legno
fr_Structure en bois

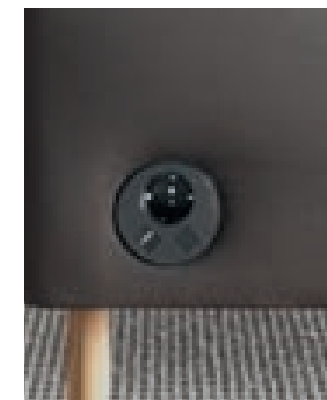

en_Cable management, custom power module
it_Elettrificazione, a richiesta diverse prese di corrente
fr_Electrification, sur demande différentes prises



Inattesa

en_It is an upholstered system which includes armchairs, sofas with low or high back, floor poufs or on feet, designed to make welcoming public and private spaces. The backrests can be customized with thermoformed fabric.

it_È un sistema di imbottiti che comprende poltroncine, divanetti con schienale basso e alto, pouf a terra o con piedini, pensati per rendere accoglienti spazi pubblici e privati. Gli schienali possono essere personalizzati con tessuto termoformato.

fr_Système de chauffeuses qui comprend fauteuils, canapés avec dossier bas et haut, poufs avec ou sans pieds, conçus pour créer espaces publics et privés accueillants. Les dossiers peuvent être personnalisés avec tissu thermoformé.

Pouf / Pouf / Pouf H. 410 mm - 16 1/7"

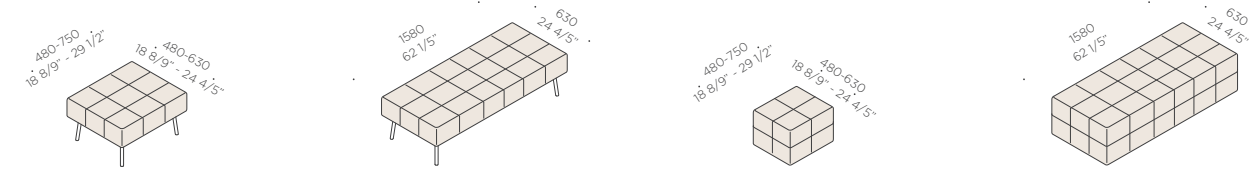

Armchair / Poltrona / Fauteuil

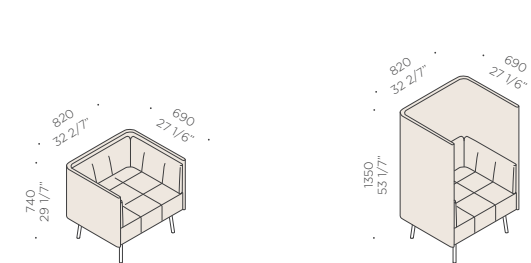

Sofa / Divano / Canapé

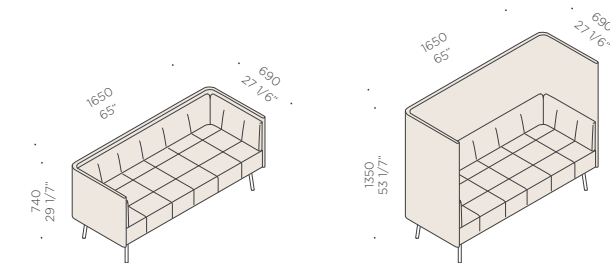

Options / Opzioni / Options



en_Thermoforming back
it_Schienale termoformato
fr_Dossier avec thermoformage

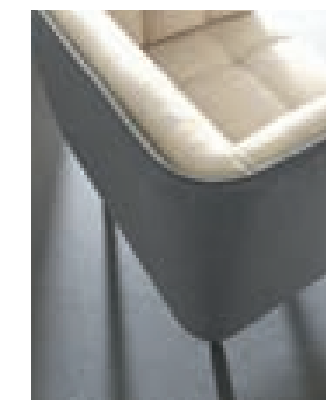

en_Smooth back
it_Schienale liscio
fr_Dossier lisse



en_Grigio Carbone lacquered feet
it_Piedini laccati Grigio Carbone
fr_Pieds laqués Grigio Carbone



en_Beech feet
it_Piedini in faggio
fr_Pieds hêtre



Nucleo panel details

Sound absorption and sound attenuation / Assorbimento acustico e attenuazione sonora / Absorption acoustique et atténuation sonore

en_The measurement of the sound attenuation of the office partition screens, intended for internal use in order to increase the privacy of speeches or the soundproofing between the workstations, according to the ISO 10053 standard, has obtained the result of acoustic abatement of 14 dB.

it_La misura dell'attenuazione sonora degli screen divisori da ufficio, intesi per l'uso interno al fine di incrementare la privacy dei discorsi o l'isolamento acustico tra le postazioni di lavoro, secondo la norma ISO 10053, ha ottenuto il risultato di abbattimento acustico di 14 dB.

fr_La mesure de l'atténuation sonore des cloisons, destinés à un usage interne pour augmenter la confidentialité des discours ou l'insonorisation entre les postes de travail, selon la norme ISO 10053, a obtenu le résultat de la réduction acoustique de 14 dB.

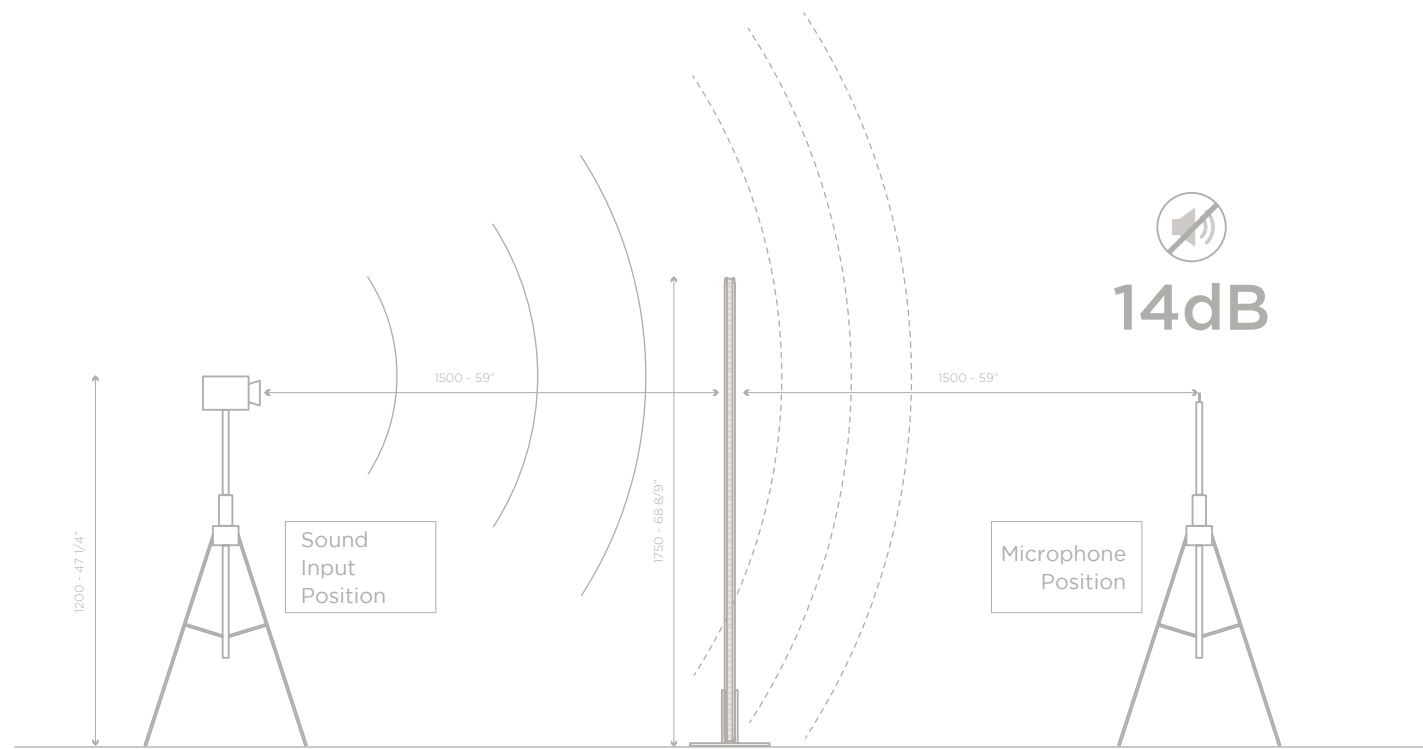

en_Test effected on straight freestanding screen H.1750 mm, according to ISO 10053 regulation

it_Prova effettuata su paravento freestanding dritto H. 1750 mm, secondo la norma ISO 10053

fr_Test effectuée sur cloison freestanding H. 1750 mm, selon la norme ISO 10053

Fixing / Montaggio / Montage

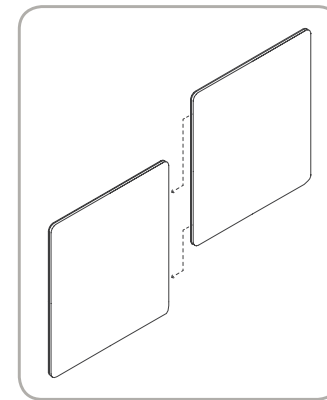

en_Quick and simple panels hooking
it_Aggancio tra pannelli facile e veloce
fr_Liaison entre panneaux simple et rapide

Wire management / Elettrificazione / Électrification

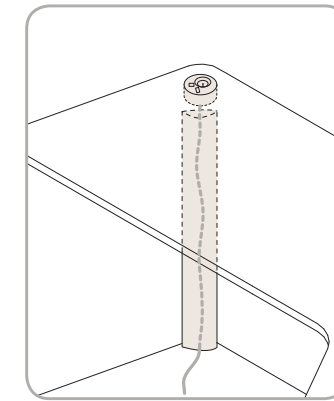

en_Socket and fabric cable riser, for desk
it_Presa e calza per la salita dei cavi, per scrivania
fr_Prise et chemin de câbles en tissu, pour bureau

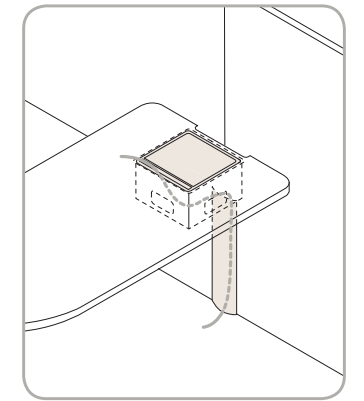

en_Flap and fabric cable riser, for meeting table
it_Sportello e calza per salita cavi, per tavolo riunione
fr_Top access et chemin de câbles, pour table de réunion

Accessories / Accessori / Accessoires

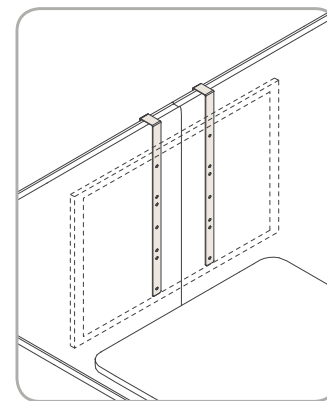

en_Brackets for tv monitor
it_Staffa aggancio monitor tv
fr_Support porte écran

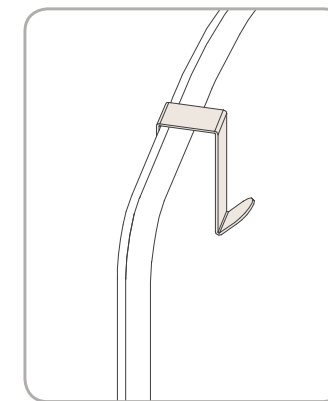

en_Coat and bags hanger hook
it_Gancio appendi giacca o borse
fr_Crochet porte-cintres ou sac

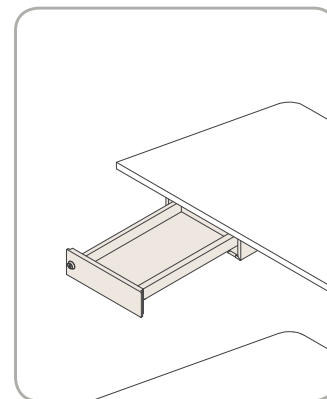

en_Personal drawer with optional usb charger
it_Cassettino porta oggetti con o senza usb
fr_Tiroir plumier - prise USB en option

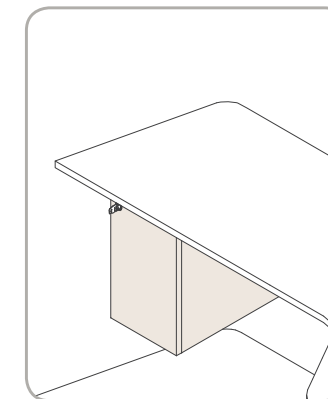

en_Bag holder with lock
it_Porta borsa con serratura
fr_Box porte-sac avec serrure

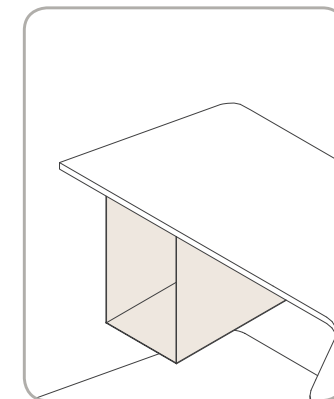

en_Cpu holder
it_Porta cpu
fr_Support uc

Nucleo Temporary work

en_Modular workstations where to find privacy and concentration. The compositions can be configured in single, double or repeated positions, without limits, in different layout proposals according to every need.

it_Sono postazioni modulari dove trovare privacy e concentrazione. Le composizioni sono configurabili in postazioni singole, doppie o ripetute senza limiti, in diverse proposte di layout a seconda delle esigenze.

fr_Situations modulaires de travail où trouver intimité et concentration. Les compositions peuvent être configurées dans des positions individuels, doubles ou répétées sans limites dans différentes propositions selon les besoins, les fonctions et l'espace.

Heights / Altezze / Hauteur

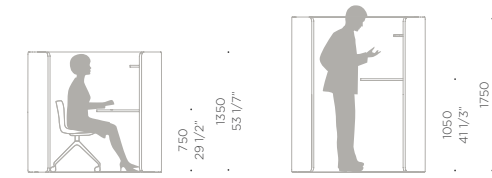

Single / Singolo / Individuel

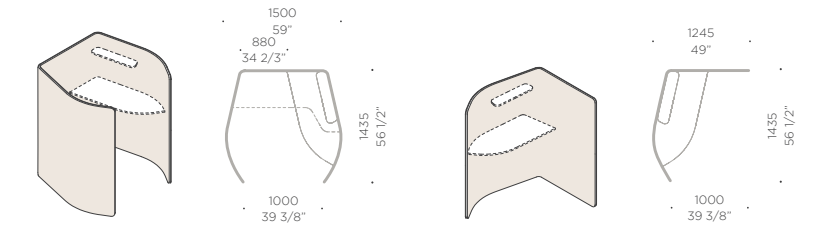

Double / Doppio / Double

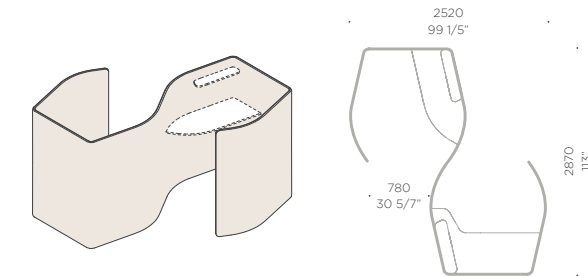
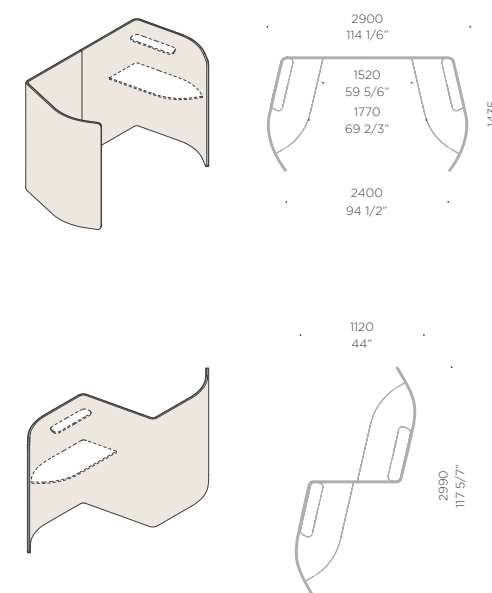

Tops and shelf / Piani e mensola / Plateaux et étagère

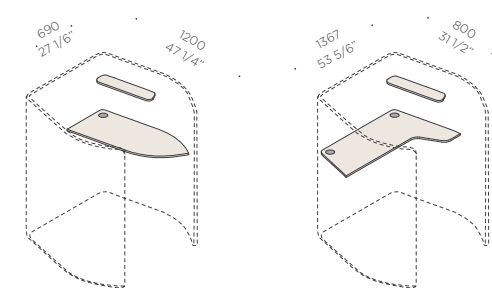

en_Side top with 1 cable port
it_Piano laterale con 1 passacavo
fr_Plateau latéral avec 1 top access

en_Front top with 2 cable ports
it_Piano frontale con 2 passacavi
fr_Plateau frontal avec 2 top access

Wire management / Elettrificazione / Électrification

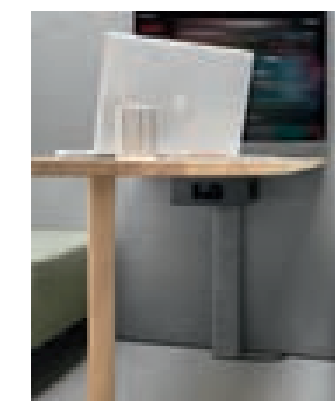

en_Cable raising through upholstered pocket
it_Salta cavi tramite calza in tessuto
fr_Remontée des câbles recouvert de tissu

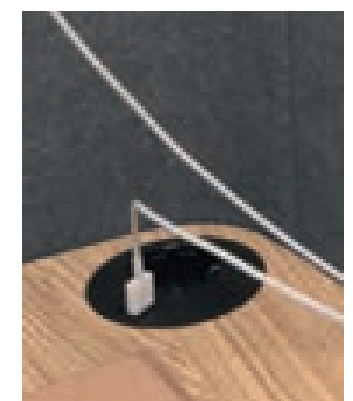

en_Top wire management
it_Elettrificazione piano
fr_Électrification plateau



Nucleo Meeting

en_Nucleo Meeting offers flexibility for small meeting rooms. It allows solutions with high or low tables and integrated electrification. For the seating you can choose solutions with chairs, stools or comfortable integrated poufs.

it_Nucleo Meeting offre flessibilità per piccole sale riunioni. Permette soluzioni con tavoli alti o bassi ed elettrificazione integrata. Per le sedute si possono scegliere soluzioni con sedie, sgabelli o comodi pouf integrati.

fr_Nucleo Meeting offre la flexibilité pour créer petites salles de réunion dans l'espace ouvert. Il permet des solutions avec tables hautes ou basses et l'électrification intégrée. Vous pouvez choisir solutions avec des chaises, tabourets ou poufs intégrés et confortables.

Heights / Altezze / Hauteur

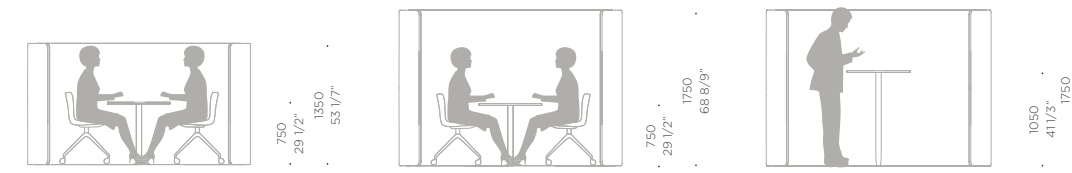

Modularity / Modularità / Modularité

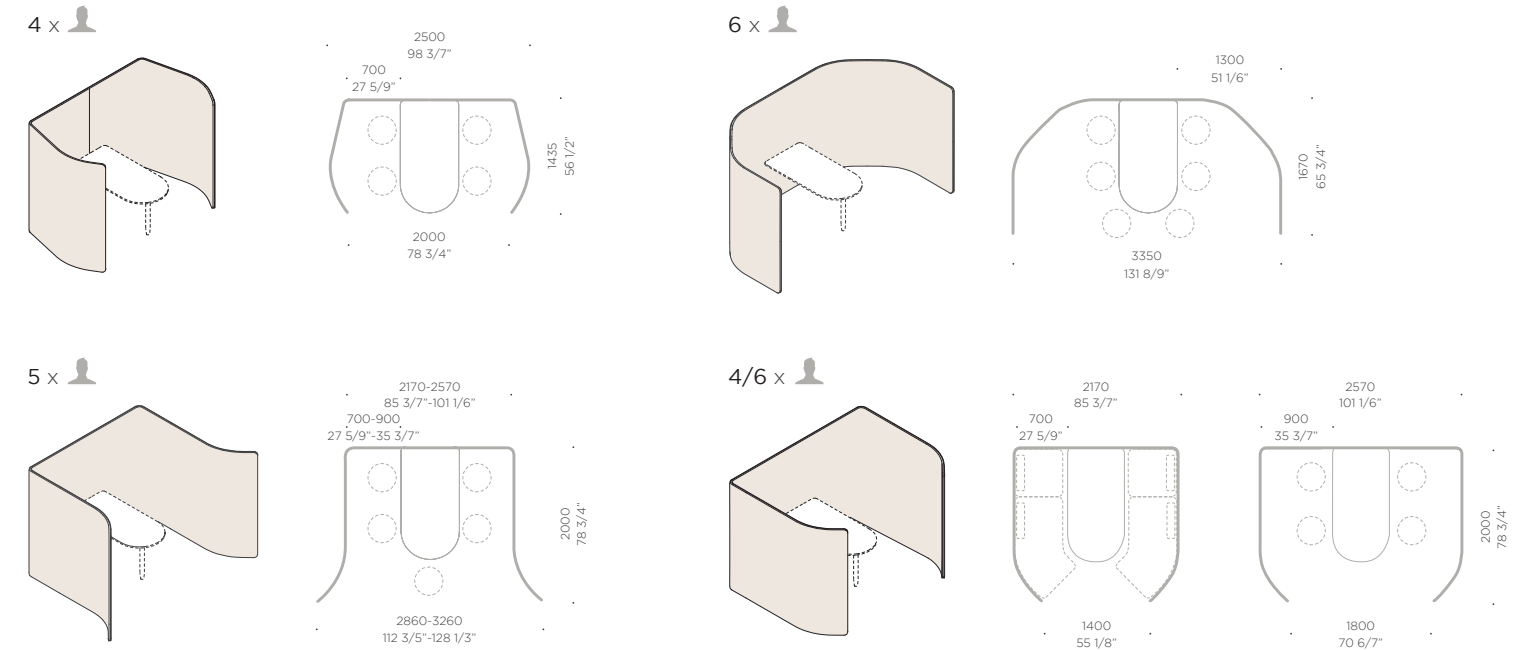

Top / Piano / Plateau

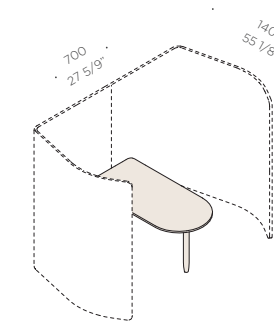

en_Hooked top
it_Piano agganciato
fr_Plateau accroché

Wire management / Elettrificazione / Électrification

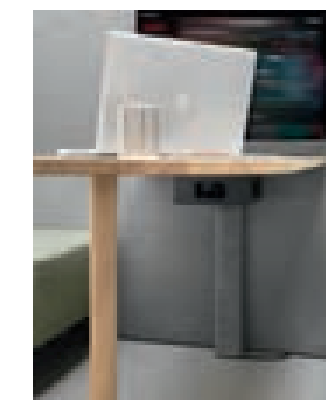

en_Cable raising through upholstered pocket
it_Salita cavi tramite calza in tessuto
fr_Remontée des câbles recouvert de tissu



en_Cable port, cable tray included
it_Sportello passacavi comprensivo di vaschetta
fr_Top access, bac porte câbles inclus



Nucleo Waiting

en_With Nucleo you can create comfortable living areas that allow isolation and privacy in open spaces.

it_Con Nucleo è possibile creare confortevoli salottini che permettono isolamento e privacy in spazi aperti.

fr_Avec Nucleo vous pouvez créer des salons confortables qui permettent l'isolement et l'intimité dans les espaces ouverts.

Heights / Altezze / Hauteur

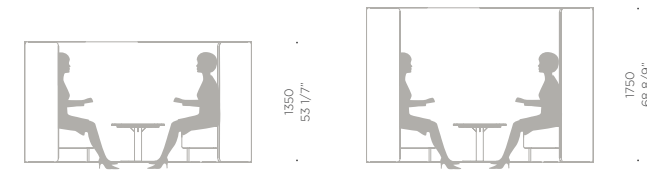

Modularity / Modularità / Modularité

4 x

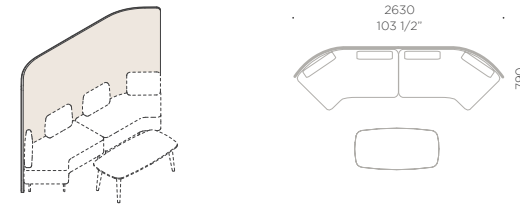

4 x

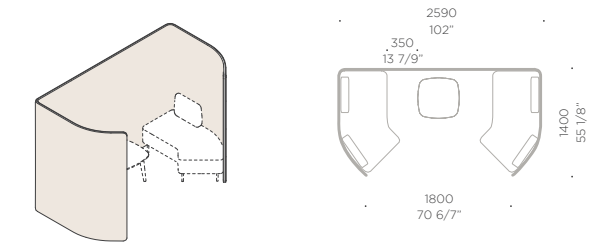

6 x

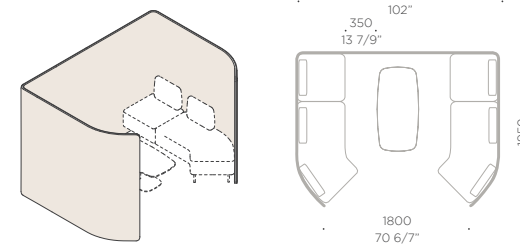

8 x

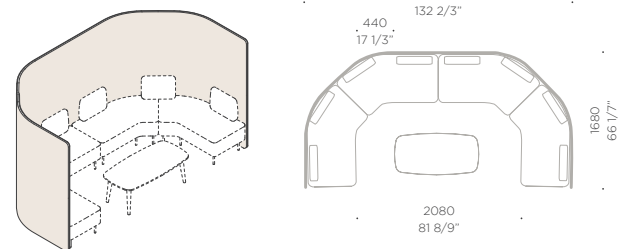

10 x

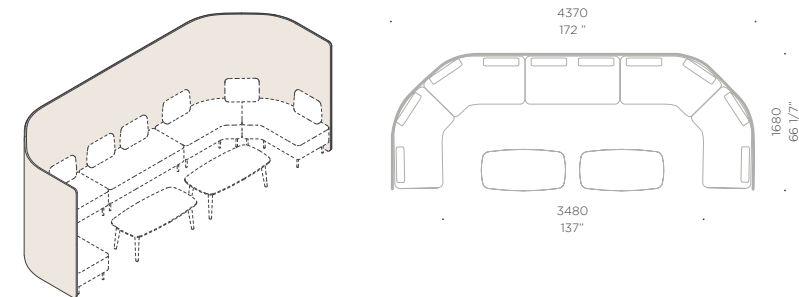

Nucleo Freestanding

en_The screen is a flexible and modular partition that can be multiplied to infinity. It can be double-sided with different fabrics or colors between the 2 sides and can be equipped with hooks for coats, bags or white boards.

it_Il paravento è un divisorio flessibile e componibile che può moltiplicarsi all'infinito. Può essere bifacciale con tessuti o colori diversi tra i 2 lati e può essere attrezzato con agganci per cappotti, borse o lavagne.

fr_ La cloison est une partition flexible et modulaire qui peut se multiplier à l'infini. Il peut être à double face avec différents tissus ou couleurs entre les 2 côtés et peut être équipé de crochets pour manteaux, sacs ou tableaux noirs.

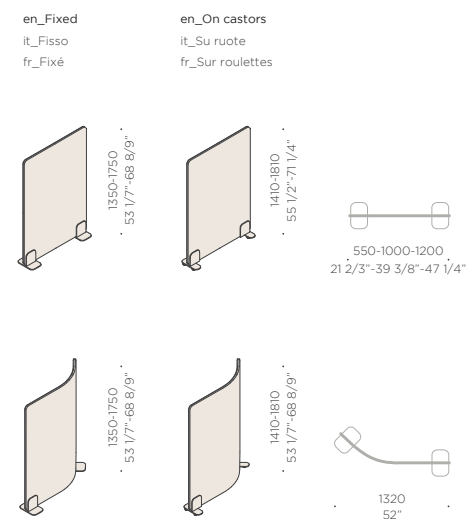

Nucleo Phone booth

en_The Martex Phone booth, thanks to the use of sound-absorbing materials, is mainly used in open space areas where it is necessary to have small isolated and quieter areas to make business calls or for short private conversations.

it_Il Phone booth Martex, grazie all'utilizzo di materiali fonoassorbenti, viene utilizzato principalmente in aree di open space dove è necessario avere delle piccole aree isolate e più silenziose per poter effettuare chiamate di lavoro o per brevi conversazioni private.

fr_Le Phone booth Martex, grâce à l'utilisation de matériaux absorbant, est principalement utilisée dans les espaces ouverts où il est nécessaire d'avoir de petites zones isolées et plus calmes pour faire des appels professionnels ou pour de courtes conversations privées.

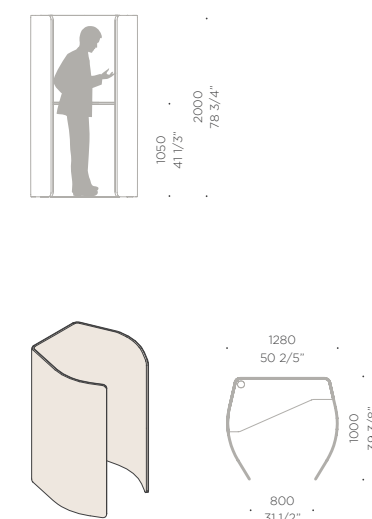

Nucleo Pantry

en_The Pantry is a service cabinet designed to furnish break areas but also to be inserted in elegant meeting rooms. It has been designed to support and contain equipment for the preparation of coffee and drinks but also to accommodate tables of H. 750 or 1050 mm.

it_La Pantry è un mobile di servizio pensato per arredare aree break ma anche per essere inserita in eleganti sale riunioni. È stata progettata per supportare e contenere attrezzature per la preparazione di caffè e bevande ma anche per accogliere tavoli da H. 750 o 1050 mm.

fr_La Pantry est une armoire de service conçue pour aménager les espaces break mais également pour être insérée dans d'élégantes salles de réunion. Il a été conçu pour supporter et contenir des équipements pour la préparation de café et de boissons mais aussi pour accrocher des tables H. 750 ou 1050 mm.

Modularity / Modularità / Modularité

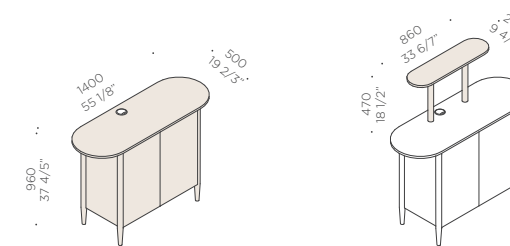

en_Pantry
it_Pantry
fr_Pantry

en_Shelf with or without LED light
it_Mensola con o senza LED
fr_Étagère avec ou sans LED

Hooked tables / Tavoli agganciabili / Tables accrochées

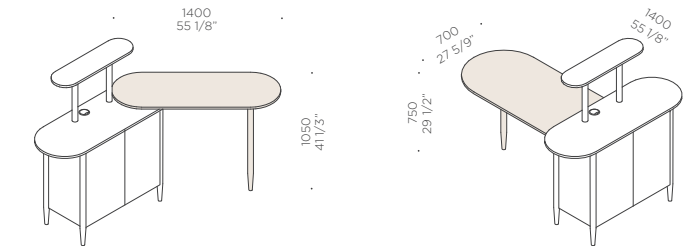

en_Table H. 1050 mm - 41 1/3"
it_Tavolo H. 1050 mm - 41 1/3"
fr_Table H. 1050 mm - 41 1/3"

en_Table H. 750 mm - 29 1/2"
it_Tavolo H. 750 mm - 29 1/2"
fr_Table H. 750 mm - 29 1/2"

Repositioning / Riposizionabilità / Repositionnement



en_High table H. 1100 mm, can be freely positioned during assembly
it_Tavolo alto H. 1100 mm posizionabile a piacimento durante la fase di montaggio
fr_Table haut H. 1100 mm, qui peut être positionnée dans toutes les positions pendant le montage

Options / Opzioni / Options

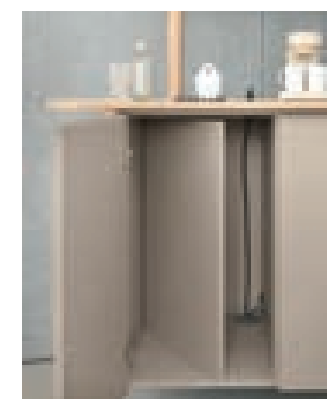

en_Integrated wire management
it_Elettificazione integrata
fr_Électrification intégré



en_LED light on shelf
it_Luce LED su mensola
fr_Lumière LED pour étagère



en_Interior with 6 shelves
it_Interno con 6 ripiani
fr_Intérieur avec 6 étagères



en_Interior with fridge + 4 shelves
it_Interno con frigo + 4 ripiani
fr_Intérieur avec réfrigérateur + 4 étagères



Nucleo Corner

en_Galaxy, combined with the partition panels, allows you to create functional kitchen corners or to simply isolate printer areas in the office.

it_Galaxy abbinato ai pannelli separatori permette di creare funzionali angoli cucina o semplicemente di isolare le aree stampanti nelle zone ufficio.

fr_Galaxy combiné avec les panneaux séparateurs vous permet de créer des coins de cuisine fonctionnels ou simplement d'isoler les zones de l'imprimante dans les zones de bureau.

Modularity / Modularità / Modularité

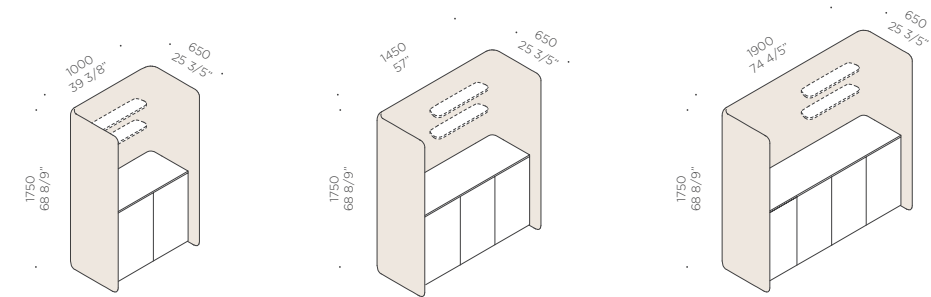

Shelves / Mensole / Étagère

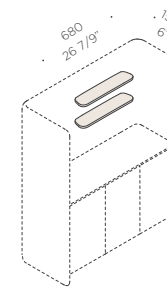

Accessories / Accessori / Accessoires



en_EU + USB wire management
it_Elettrificazione EU + USB
fr_Electrification EU + USB



en_USA + USB wire management
it_Elettrificazione USA + USB
fr_Electrification prise USA et USB



en_LED light on shelf
it_Luce LED su mensola
fr_Lumière LED pour étagère



Nucleo Table

en_The high table is an optimal solution for socializing in the break areas within the office.

it_Il tavolo alto è una soluzione ottimale per la socializzazione nelle aree break all'interno dell'ufficio.

fr_La table haute est une solution optimale pour socialiser dans les zones de pause à l'intérieur du bureau.

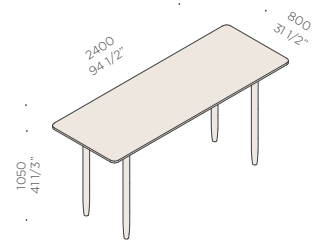

Nucleo Coffee tables

en_It is possible to use and place a wide range of low tables in every situation where it is necessary a small support surface.

it_È possibile utilizzare e posizionare un'ampia gamma di tavolini in qualsiasi situazione in cui sia necessario un piccolo piano d'appoggio.

fr_Il est possible d'utiliser et de placer une large gamme de tables dans toutes les situations où une petite surface de support est nécessaire.

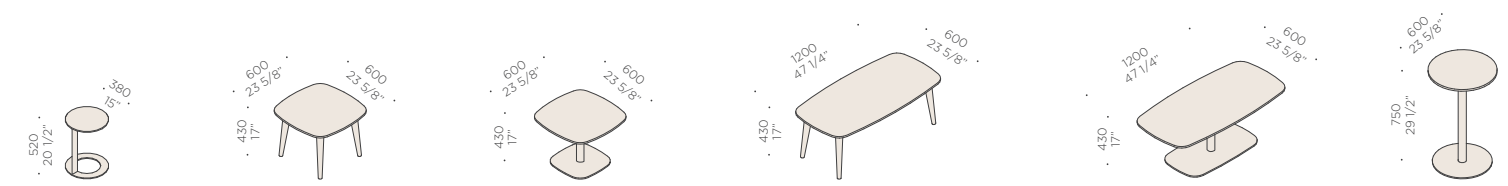

Nucleo Stool

en_Stools are ideal for informal offices, for temporary workstations, or to furnish break areas. Colorful, comfortable and practical, Martex office stools are combinable with the whole collection.

it_Gli sgabelli sono ideali per un ufficio informale, per postazioni di lavoro temporanee, o per arredare aree break. Colorati, comodi e pratici, gli sgabelli da ufficio Martex si abbinano a tutta la collezione.

fr_Les tabourets sont idéales pour un bureau informel, pour des postes de travail provisoires, ou pour aménager espaces break et collectivité. Colorées, confortables et pratiques, les tabourets de bureau de Martex sont assorties avec toute la collection Nucleo.

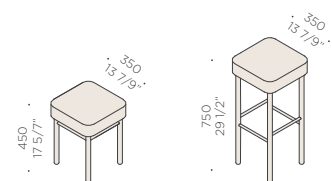

Nucleo Chair

en_Seat with wood structure, with customizable shell in Martex lacquered colors or fabric upholstered.

it_Seduta con struttura legno, con scocca personalizzabile nei colori laccati Martex a catalogo oppure rivestita in tessuto.

fr_Siège avec structure en bois personnalisable dans les couleurs laquées Martex ou tapissé.

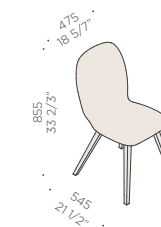

Standard Colours & Finishes

en_Colours for reference only and may vary from original. Fabrics and leathers from different lots may be subject to colour variations. Any differences will not be recognized as a complaint.

it_Campioni colore indicativi, possono differire dall'originale. Tessuti e pelli possono essere soggetti a cambiamenti e a differenze tra lotti diversi. Eventuali differenze non verranno riconosciute come reclamo.

fr_Echantillons de coloris indicatifs, ils peuvent différer de l'original. Tissu et cuir de différents lots peuvent être soumis à des changements et à des différences de couleur. Les éventuelles différences ne seront pas reconnus comme une grief.

WO - SOLID WOOD / LEGNO MASSELLO / BOIS MASSIF



003 rovere massello

MEL - MELAMINE / MELAMINICO / MÉLAMINE

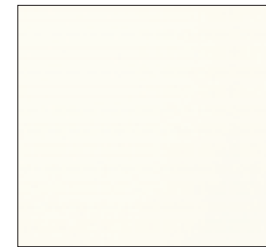

038 bianco

LAC - MATT LACQUERED COLOURS / LACCATI OPACHI / LAQUÉ MAT



401 bianco 430 pioggia 427 corda 403 crema 431 roccia 428 cappuccino 406 tortora 408 verde oliva



432 avio 421 oca 413 amarena 417 titanio 418 fondente 429 ombra 419 grigio carbone 420 nero

CAT. A - FABRIC STRETCHY 3D / TESSUTO STRETCHY 3D / TISSU STRETCHY 3D



881 bianco 887 tortora 882 verde oliva 884 viola 886 blu scuro 888 grigio chiaro 885 grigio scuro 889 nero

CAT. B - FAUX-LEATHER 3D / ECOPELLE 3D / SIMILCUIR 3D



901 bianco 902 canapo 903 testa di moro 906 nero

CAT. C - FABRIC ANGEL / TESSUTO ANGEL / TISSU ANGEL

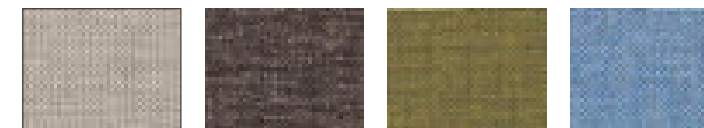

860 beige 861 marrone scuro 862 verde 863 azzurro

CAT. E - FAUX-LEATHER / ECOPELLE / SIMILCUIR

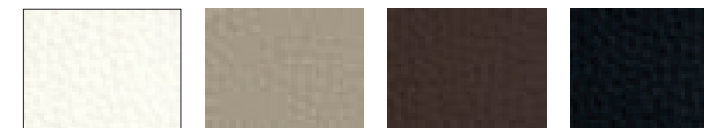

921 bianco 924 canapo 930 testa di moro 932 nero

CAT. D - FABRIC STOPFIRE / TESSUTO STOPFIRE / TISSU STOPFIRE



891 bianco 897 tortora 961 marrone 894 pistacchio 960 avio 890 oca 893 grigio chiaro 962 grigio scuro

CAT. H - FABRIC LUNA 2 / TESSUTO LUNA 2 / TISSU LUNA 2



984 panna 982 marrone chiaro 986 moka 983 verde 987 avio 981 grigio chiaro 985 grigio scuro

CAT. I - FABRIC CAPTURE / TESSUTO CAPTURE / TISSU CAPTURE

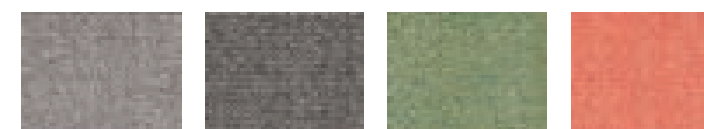

951 grigio chiaro 954 grigio scuro 957 verde 950 corallo

Martex reserves the rights at all time to apply modifications for the functional or qualitative improvement of its products. Texts and drawings present in this brochure have a divulgative purpose: for every technical and dimensional aspect please refer to the company's price lists and their relative updating. The colour and material samples have an indicative value.

Martex si riserva il diritto di apportare, senza preavviso, ogni modifica mirata al miglioramento funzionale e qualitativo dei propri prodotti. Testi e disegni presenti in questo stampato hanno scopo divulgativo: per ogni aspetto tecnico e dimensionale fare riferimento ai listini aziendali e relativi aggiornamenti. I campioni di colori e materiali hanno valore indicativo.

Martex se réserve le droit d'apporter, sans préavis, toute modification utile à améliorer la fonctionnalité et la qualité de ses produits. Les textes et dessins dans ce document sont pour des fins d'information: pour tous les aspects techniques et de dimensions il faut se référer aux tarifs et relatives mises à jour. Les échantillons de couleurs et de matériaux ont une valeur indicative.

Concept: Studio Monica Graffeo
Graphics: MKT Martex
Photo: Gabriotti Fotografi
Art Buyer: Carla Bernardis
Print: Sinchromia
Photolitho: Lucegroup

October 2018

Martex is certified
UNI EN ISO 9001:2008

Martex S.p.A.
via Sagré, 19 - 33080
Prata di Pordenone (PN) Italy
tel +39 0434 602310
fax +39 0434 602319

info@martex.it
www.martex.it

