





















POULE

Sizes - Packaging

H. 73/75 cm H. 283/8"/294/8"		1 pz. colli m ³ Kg		2 pz. colli m ³ Kg		3 pz. colli m ³ Kg		H. 108/110 cm H. 424/8"/432/8"		1 pz. colli m ³ Kg		2 pz. colli m ³ Kg		3 pz. colli m ³ Kg							
	Ø 59 cm Ø 235/8"	20	,411	4	30	,672	8	40	,673	8		Ø 59 cm Ø 235/8"	20	,631	6	31	,033	2	41	,064	3
	59 x 59 235/8 x 235/8"	20	,411	4	30	,672	8	40	,673	8		59 x 59 cm 235/8 x 235/8"	20	,631	6	31	,033	2	41	,064	3
	Ø 69 Ø 271/8"	20	,421	5	30	,682	9	40	,684	1		Ø 69 cm Ø 271/8"	20	,641	7	31	,053	3	41	,084	4
	69 x 69 271/8 x 271/8"	20	,421	5	30	,682	9	40	,684	1		100 x 59 cm 393/8 x 235/8"	21	,002	6	31	,824	9	41	,906	9
	Ø 90 Ø 353/8"	20	,632	5	31	,154	5	41	,226	5		120 x 59 cm 472/8 x 235/8"	21	,002	8	31	,825	3	41	,907	5
	Ø 100 Ø 393/8"	20	,632	7	31	,154	9	41	,227	1		100 x 69 cm 393/8 x 274/8"	21	,022	7	31	,865	1	41	,967	2
	100 x 59 393/8 x 235/8"	20	,642	4	31	,154	6	41	,206	5		120 x 69 cm 472/8 x 274/8"	21	,022	9	31	,865	5	41	,967	8
	120 x 59 472/8 x 235/8"	20	,642	6	31	,155	0	41	,207	1		150 x 69 cm 59 x 274/8"	21	,253	2	32	,216	0	42	,288	5
	100 x 69 393/8 x 274/8"	20	,662	5	31	,194	8	41	,266	8											
	120 x 69 472/8 x 274/8"	20	,662	7	31	,195	2	41	,267	4											
	150 x 69 59 x 274/8"	20	,823	0	31	,455	7	41	,528	2											
	120 x 79 472/8 x 314/8"	20	,662	8	31	,195	6	41	,268	0											
	150 x 79 59 x 314/8"	20	,833	1	31	,476	1	41	,558	8											

Tops 10 mm thick

Laminate

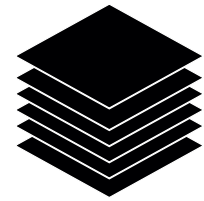
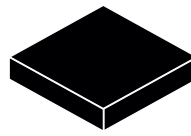

- laminate
- black core
- laminate

Pure-white

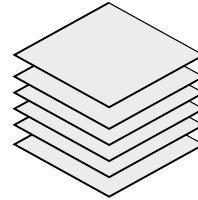
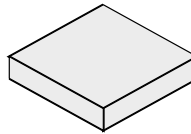

- laminate
- white core
- laminate

Fenix-NTM® black edge

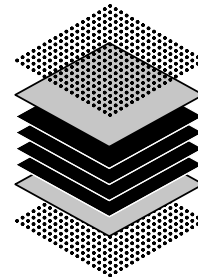
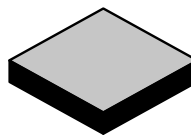

- surface obtained with the aid of nanotechnology
- decorative paper
- Kraft paper core
- decorative paper
- surface obtained with the aid of nanotechnology

POULE

Table H. 73 cm - Fixed top

Base finish:

White lacquered aluminium (similar to RAL 9016)

Black lacquered aluminium (similar to RAL 9004)

Finish of top:

Black laminate

Pure-white laminate

Fenix-NTM® black edge (Ingo black 0720)

Note:

For packaging specifications, see page 242.

Reinforced packaging, see inside cover.

Code	Dimensions	Top			pack	m ²	Kg
		Black laminate	Fenix-NTM®	Pure-white laminate			
01POL01R	Ø 59						
01POL01Q	59 x 59						
01POL03R	Ø 69						
01POL03Q	69 x 69						

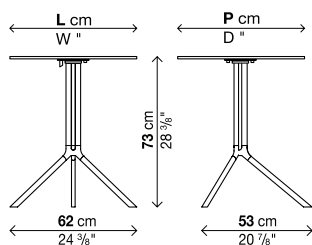

POULE

Table H. 75 cm - Tip-up top

Base finish:

White lacquered aluminium (similar to RAL 9016)

Black lacquered aluminium (similar to RAL 9004)

Finish of top:

Black laminate

Pure-white laminate

Fenix-NTM® black edge (Ingo black 0720)

Note:

For packaging specifications, see page 242.

Reinforced packaging, see inside cover.

Code	Dimensions	Top			pack	m ³	Kg
		Black laminate	Fenix-NTM®	Pure-white laminate			
01POL04R	Ø 59						
01POL04Q	59 x 59						
01POL07R	Ø 69						
01POL07Q	69 x 69						

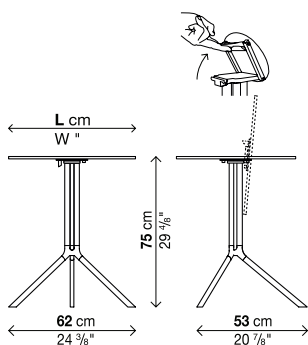

POULE

Table H. 73 cm - Fixed top

Base finish:

White lacquered aluminium (similar to RAL 9016)

Black lacquered aluminium (similar to RAL 9004)

Finish of top:

Black laminate

Pure-white laminate

Fenix-NTM® black edge (Ingo black 0720)

Note:

For packaging specifications, see page 242.

Reinforced packaging, see inside cover.

Code	Dimensions	Top			pack	m ²	Kg
		Black laminate	Fenix-NTM®	Pure-white laminate			
01POL13	Ø 90						
01POL21	Ø 100						
01POL22	100 x 59						
01POL10	120 x 59						
01POL23	100 x 69						
01POL24	120 x 69						
01POL14	150 x 69						
01POL12	120 x 79						
01POL16	150 x 79						

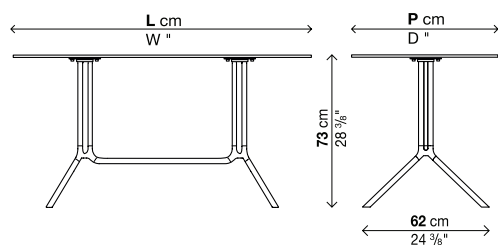

POULE

Table H. 75 cm - Tip-up top

Base finish:

White lacquered aluminium (similar to RAL 9016)

Black lacquered aluminium (similar to RAL 9004)

Finish of top:

Black laminate

Pure-white laminate

Fenix-NTM® black edge (Ingo black 0720)

Note:

For packaging specifications, see page 242.

Reinforced packaging, see inside cover.

Code	Dimensions	Top			pack	m ³	Kg
		Black laminate	Fenix-NTM®	Pure-white laminate			
01POL09	Ø 90						
01POL19	Ø 100						
01POL25	100 x 59						
01POL11	120 x 59						
01POL26	100 x 69						
01POL27	120 x 69						
01POL15	150 x 69						
01POL17	120 x 79						
01POL18	150 x 79						

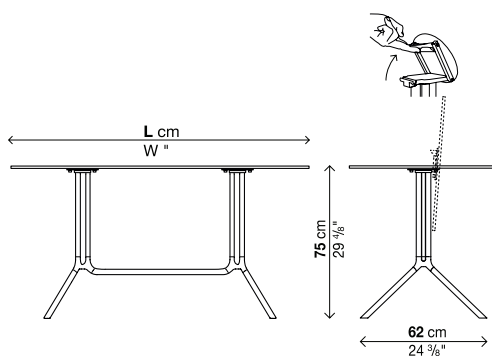

POULE

High table H. 108 cm - Fixed top

Base finish:

White lacquered aluminium (similar to RAL 9016)

Black lacquered aluminium (similar to RAL 9004)

Finish of top:

Black laminate

Pure-white laminate

Fenix-NTM® black edge (Ingo black 0720)

Note:

For packaging specifications, see page 242.

Reinforced packaging, see inside cover.

Code	Dimensions	Top			pack	m ²	Kg
		Black laminate	Fenix-NTM®	Pure-white laminate			
01POL02R	Ø 59						
01POL02Q	59 x 59						
01POL06R	Ø 69						

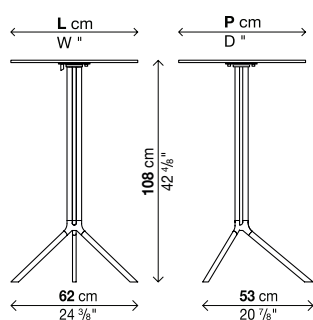

POULE

High table H. 110 cm - Tip-up top

Base finish:

White lacquered aluminium (similar to RAL 9016)

Black lacquered aluminium (similar to RAL 9004)

Finish of top:

Black laminate

Pure-white laminate

Fenix-NTM® black edge (Ingo black 0720)

Note:

For packaging specifications, see page 242.

Reinforced packaging, see inside cover.

Code	Dimensions	Top			pack	m ³	Kg
		Black laminate	Fenix-NTM®	Pure-white laminate			
01POL05R	Ø 59						
01POL05Q	59 x 59						
01POL08R	Ø 69						

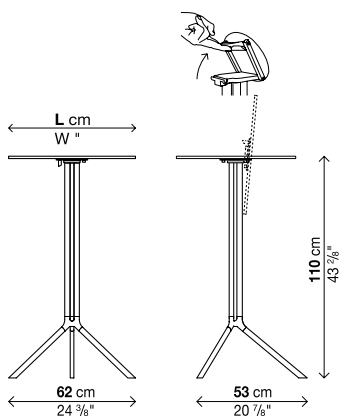

POULE

High table H. 108 cm - Fixed top

Base finish:

White lacquered aluminium (similar to RAL 9016)

Black lacquered aluminium (similar to RAL 9004)

Finish of top:

Black laminate

Pure-white laminate

Fenix-NTM® black edge (Ingo black 0720)

Note:

For packaging specifications, see page 242.

Reinforced packaging, see inside cover.

Code	Dimensions	Top			pack	m ²	Kg
		Black laminate	Fenix-NTM®	Pure-white laminate			
01POL30	100 x 59						
01POL31	120 x 59						
01POL32	100 x 69						
01POL33	120 x 69						
01POL34	150 x 69						

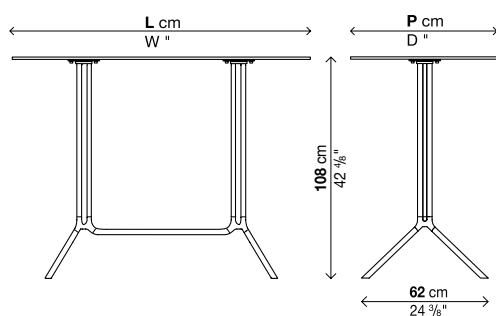

POULE

High table H. 110 cm - Tip-up top

Base finish:

White lacquered aluminium (similar to RAL 9016)

Black lacquered aluminium (similar to RAL 9004)

Finish of top:

Black laminate

Pure-white laminate

Fenix-NTM® black edge (Ingo black 0720)

Note:

For packaging specifications, see page 242.

Reinforced packaging, see inside cover.



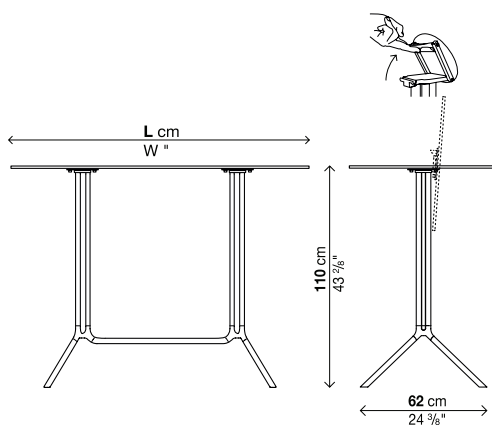













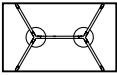

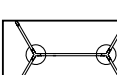

Code	Dimensions	Top			pack	m ³	Kg
		Black laminate	Fenix-NTM®	Pure-white laminate			
01POL40	100 x 59						
01POL41	120 x 59						
01POL42	100 x 69						
01POL43	120 x 69						
01POL44	150 x 69						

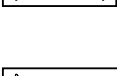

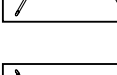
Kristalia - Poule Outdoor

Poule / Poule Double

Sizes - packaging

H. 73/75 cm H. 283/8"/294/8"		1 pz. Packs m ³ Kg	2 pz. Packs m ³ Kg	3 pz. Packs m ³ Kg	H. 107/110 cm H. 421/8"/432/8"		1 pz. Packs m ³ Kg	2 pz. Packs m ³ Kg	3 pz. Packs m ³ Kg
	Ø 59 cm Ø 235/8"	2 0,41 14	3 0,67 28	4 0,67 38		Ø 59 cm Ø 235/8"	2 0,63 16	3 1,03 32	4 1,06 43
	59 x 59 cm 235/8 x 235/8"	2 0,41 14	3 0,67 28	4 0,67 38		59 x 59 cm 235/8 x 235/8"	2 0,63 16	3 1,03 32	4 1,06 43
	Ø 69 cm Ø 271/8"	2 0,42 15	3 0,69 29	4 0,69 41		Ø 69 cm Ø 271/8"	2 0,64 17	3 1,05 33	4 1,08 44
	69 x 69 cm 271/8 x 271/8"	2 0,42 15	3 0,69 29	4 0,69 41		100 x 60 cm 393/8 x 235/8"	2 1,00 26	3 1,82 49	4 1,90 69
	Ø 90 cm Ø 353/8"	2 0,63 25	3 1,15 45	4 1,22 65		120 x 59 cm 472/8 x 235/8"	2 1,00 28	3 1,82 53	4 1,90 75
	Ø 100 cm Ø 393/8"	2 0,63 27	3 1,15 49	4 1,22 71		100 x 69 cm 393/8 x 274/8"	2 1,02 27	3 1,86 51	4 1,96 72
	100 x 59 cm 393/8 x 235/8"	2 0,64 24	3 1,15 46	4 1,20 65		120 x 69 cm 472/8 x 274/8"	2 1,02 29	3 1,86 55	4 1,96 78
	120 x 59 cm 472/8 x 235/8"	2 0,64 26	3 1,15 50	4 1,20 71		150 x 69 cm 59 x 274/8"	2 1,25 32	3 2,21 60	4 2,28 85
	100 x 69 cm 393/8 x 274/8"	2 0,66 25	3 1,19 48	4 1,26 68					
	120 x 69 cm 472/8 x 274/8"	2 0,66 27	3 1,19 52	4 1,26 74					
	150 x 69 cm 59 x 274/8"	2 0,82 30	3 1,45 57	4 1,52 82					
	120 x 79 cm 472/8 x 314/8"	2 0,66 28	3 1,19 56	4 1,26 80					
	150 x 79 cm 59 x 314/8"	2 0,83 31	3 1,47 61	4 1,55 88					

Tops 10 mm thick

Laminate

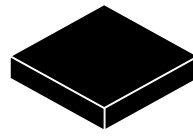

- laminate
- black core
- laminate

Pure-white

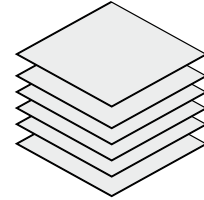
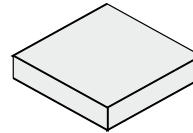

- laminate
- white core
- laminate

Fenix-NTM® black edge

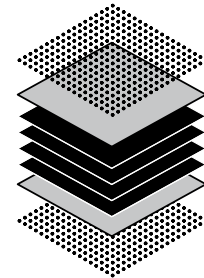
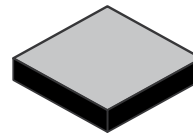

- surface obtained with the aid of nanotechnology
- decorative paper
- Kraft paper core
- decorative paper
- surface obtained with the aid of nanotechnology

Poule

Fixed or tip-up top 10 mm thick.

Finish of structure:

White lacquered aluminium (similar to RAL 9016)

Black lacquered aluminium (similar to RAL 9004)

Finish of top:

Black laminate

Pure-white laminate

Ingo black 0720 Fenix-NTM®

→ For packaging specifications, see page 40.

→ Reinforced packaging, see inside of cover.

→ "Casper" protective cover, see page 74.

Fixed top (H.73 cm)

Code	Size	Height	Top	Price in EURO	Packs	Vol. ³	Kg
01POL01R	Ø 59	73	black laminate				
			Pure-white laminate				
			Fenix-NTM				
01POL01Q	59 x 59	73	black laminate				
			Pure-white laminate				
			Fenix-NTM				
01POL03R	Ø 69	73	black laminate				
			Pure-white laminate				
			Fenix-NTM				
01POL03Q	69 x 69	73	black laminate				
			Pure-white laminate				
			Fenix-NTM				

Tip-up top (H.75 cm)

Code	Size	Height	Top	Price in EURO	Packs	Vol. ³	Kg
01POL04R	Ø 59	75	black laminate				
			Pure-white laminate				
			Fenix-NTM				
01POL04Q	59 x 59	75	black laminate				
			Pure-white laminate				
			Fenix-NTM				
01POL07R	Ø 69	75	black laminate				
			Pure-white laminate				
			Fenix-NTM				
01POL07Q	69 x 69	75	black laminate				
			Pure-white laminate				
			Fenix-NTM				

Fixed top (H.107 cm)

Code	Size	Height	Top	Price in EURO	Packs	Vol. ³	Kg
01POL02R	Ø 59	107	black laminate				
			Pure-white laminate				
			Fenix-NTM				
01POL02Q	59 x 59	107	black laminate				
			Pure-white laminate				
			Fenix-NTM				
01POL06R	Ø 69	107	black laminate				
			Pure-white laminate				
			Fenix-NTM				

Tip-up top (H.110 cm)

Code	Size	Height	Top	Price in EURO	Packs	Vol. ³	Kg
01POL05R	Ø 59	110	black laminate				
			Pure-white laminate				
			Fenix-NTM				
01POL05Q	59 x 59	110	black laminate				
			Pure-white laminate				
			Fenix-NTM				
01POL08R	Ø 69	110	black laminate				
			Pure-white laminate				
			Fenix-NTM				

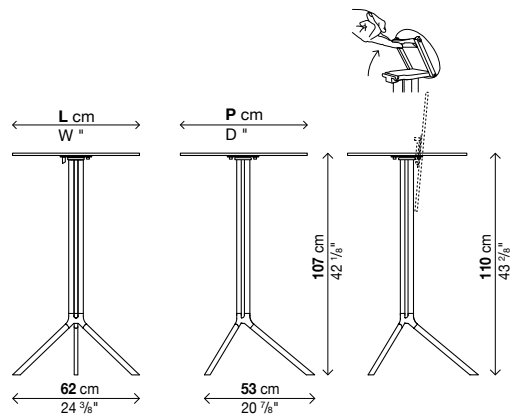
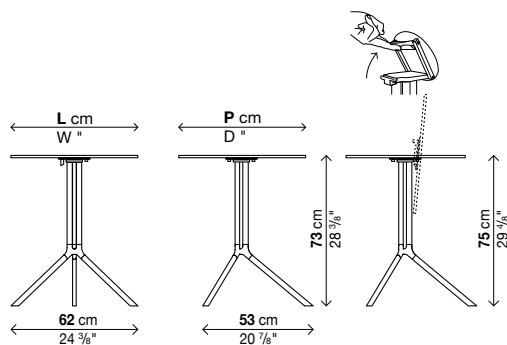

Poule Double

Fixed or tip-up top 10 mm thick.

Finish of structure:

White lacquered aluminium (similar to RAL 9016)
 Black lacquered aluminium (similar to RAL 9004)

Finish of top:

Black laminate
 Pure-white laminate
 Ingo black 0720 Fenix-NTM®

→ For packaging specifications, see page 40.

→ Reinforced packaging, see inside of cover.

→ "Casper" protective cover, see page 74.

Fixed top (H.73 cm)

Code	Size	Height	Top	Price in EURO	Packs	Vol.³	Kg
01POL13	Ø 90	73	black laminate				
			Pure-white laminate				
			Fenix-NTM				
01POL21	Ø 100	73	black laminate				
			Pure-white laminate				
			Fenix-NTM				
01POL22	100 x 59	73	black laminate				
			Pure-white laminate				
			Fenix-NTM				
01POL10	120 x 59	73	black laminate				
			Pure-white laminate				
			Fenix-NTM				
01POL23	100 x 69	73	black laminate				
			Pure-white laminate				
			Fenix-NTM				
01POL24	120 x 69	73	black laminate				
			Pure-white laminate				
			Fenix-NTM				
01POL14	150 x 69	73	black laminate				
			Pure-white laminate				
			Fenix-NTM				
01POL12	120 x 79	73	black laminate				
			Pure-white laminate				
			Fenix-NTM				
01POL16	150 x 79	73	black laminate				
			Pure-white laminate				
			Fenix-NTM				

Tip-up top (H.75 cm)

Code	Size	Height	Top	Price in EURO	Packs	Vol.³	Kg
01POL09	Ø 90	75	black laminate				
			Pure-white laminate				
			Fenix-NTM				
01POL19	Ø 100	75	black laminate				
			Pure-white laminate				
			Fenix-NTM				
01POL25	100 x 59	75	black laminate				
			Pure-white laminate				
			Fenix-NTM				
01POL11	120 x 59	75	black laminate				
			Pure-white laminate				
			Fenix-NTM				
01POL26	100 x 69	75	black laminate				
			Pure-white laminate				
			Fenix-NTM				
01POL27	120 x 69	75	black laminate				
			Pure-white laminate				
			Fenix-NTM				
01POL15	150 x 69	75	black laminate				
			Pure-white laminate				
			Fenix-NTM				
01POL17	120 x 79	75	black laminate				
			Pure-white laminate				
			Fenix-NTM				
01POL18	150 x 79	75	black laminate				
			Pure-white laminate				
			Fenix-NTM				

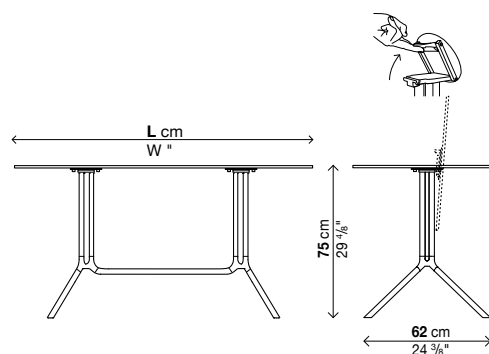
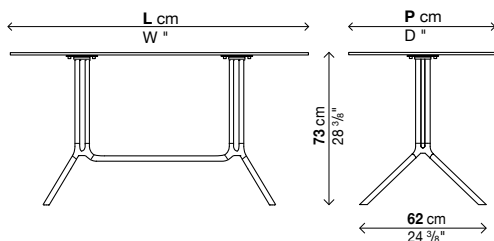

Poule Double

Fixed or tip-up top 10 mm thick.

Finish of structure:

White lacquered aluminium (similar to RAL 9016)

Black lacquered aluminium (similar to RAL 9004)

Finish of top:

Black laminate

Pure-white laminate

Ingo black 0720 Fenix-NTM®

→ For packaging specifications, see page 40.

→ Reinforced packaging, see inside of cover.

→ "Casper" protective cover, see page 74.

Fixed top (H.107 cm)

Code	Size	Height	Top	Price in EURO	Packs	Vol. ³	Kg
01POL30	100 x 59	107	black laminate				
			Pure-white laminate				
			Fenix-NTM				
01POL31	120 x 59	107	black laminate				
			Pure-white laminate				
			Fenix-NTM				
01POL32	100 x 69	107	black laminate				
			Pure-white laminate				
			Fenix-NTM				
01POL33	120 x 69	107	black laminate				
			Pure-white laminate				
			Fenix-NTM				
01POL34	150 x 69	107	black laminate				
			Pure-white laminate				
			Fenix-NTM				

Tip-up top (H.110 cm)

Code	Size	Height	Top	Price in EURO	Packs	Vol. ³	Kg
01POL40	100 x 59	110	black laminate				
			Pure-white laminate				
			Fenix-NTM				
01POL41	120 x 59	110	black laminate				
			Pure-white laminate				
			Fenix-NTM				
01POL42	100 x 69	110	black laminate				
			Pure-white laminate				
			Fenix-NTM				
01POL43	120 x 69	110	black laminate				
			Pure-white laminate				
			Fenix-NTM				
01POL44	150 x 69	110	black laminate				
			Pure-white laminate				
			Fenix-NTM				

