























ELEPHANT TABLE

Sizes - Packaging

H. 75/76 cm
H. 294/8"/297/8"

		1 pz.		2 pz.	
		colli	m ³ Kg	colli	m ³ Kg
	Ø 69 cm Ø 271/8"	2	0,30 14,8	3	0,55 29,6
	69 x 69 cm 271/8" x 271/8"	2	0,30 16,4	3	0,55 32,8
	Ø 79 cm Ø 311/8"	2	0,30 16,6	3	0,57 33,2
	79 x 79 cm 311/8" x 311/8"	2	0,30 18,7	3	0,57 37,4
	Ø 89 cm Ø 35"	2	0,32 19,1	3	0,59 37,2
	89 x 89 cm 35" x 35"	2	0,32 21,8	3	0,59 42,6
	100 x 59 cm 393/8" x 232/8"	2	0,48 22,4	3	0,90 43,8
	120 x 59 cm 472/8" x 232/8"	2	0,58 24,9	3	1,07 48,8
	100 x 69 cm 393/8" x 271/8"	2	0,49 25,3	3	0,83 49,6
	120 x 69 cm 472/8" x 271/8"	2	0,59 28,3	3	0,98 55,6
	150 x 69 cm 59" x 271/8"	2	0,73 32,1	3	1,35 63,1
	120 x 79 cm 472/8" x 311/8"	2	0,59 30,4	3	1,00 59,6
	150 x 79 cm 59" x 311/8"	2	0,74 34,8	3	1,23 68,3
	200 x 79 cm 786/8" x 311/8"	2	1,00 42,1	3	1,62 82,8

H. 105/106 cm
H. 413/8"/416/8"

		1 pz.		2 pz.	
		colli	m ³ Kg	colli	m ³ Kg
	Ø 69 cm Ø 271/8"	2	0,40 1 5,9	3	0,75 31,8
	69 x 69 cm 271/8" x 271/8"	2	0,40 1 7,5	3	0,75 35
	Ø 79 cm Ø 311/8"	2	0,41 1 7,7	3	0,77 35,4
	79 x 79 cm 311/8" x 311/8"	2	0,41 1 9,8	3	0,77 39,6
	100 x 59 cm 393/8" x 232/8"	2	0,66 24,6	3	1,20 48,2
	120 x 59 cm 472/8" x 232/8"	2	0,80 27,1	3	1,42 53,2
	100 x 69 cm 393/8" x 271/8"	2	0,67 27,5	3	1,14 54
	120 x 69 cm 472/8" x 271/8"	2	0,80 30,6	3	1,34 60
	150 x 69 cm 59" x 271/8"	2	1,01 34,1	3	1,79 67,5

H. 38/50 cm
H. 15"/19 5/8"

			1 pz.			2 pz.		
			colli	m ³	Kg	colli	m ³	Kg
	Ø 69 cm Ø 27 1/8"	laminata	2	0,21	13,5	3	0,24	25
		stone	2	0,28	23	3	0,35	47
	69 x 69 cm 27 1/8" x 27 1/8"	laminata	2	0,21	15	3	0,24	28
		stone	2	0,28	28	3	0,35	57
	Ø 79 cm Ø 31 1/8"		2	0,22	17,5	3	0,25	33
	79 x 79 cm 31 1/8" x 31 1/8"		2	0,22	19,5	3	0,25	37
	Ø 89 cm Ø 35"		2	0,23	19,5	3	0,27	37
	89 x 89 cm 35" x 35"		2	0,23	22	3	0,27	42
	100 x 59 cm 39 3/8" x 23 2/8"		2	0,35	16	3	0,38	29
	120 x 59 cm 47 2/8" x 23 2/8"	laminata	2	0,41	18,2	3	0,45	33,4
		stone	2	0,50	55	3	0,65	105
	100 x 69 cm 39 3/8" x 27 1/8"		2	0,35	18	3	0,39	33
	120 x 69 cm 47 2/8" x 27 1/8"		2	0,42	20,2	3	0,46	37,4
	150 x 69 cm 59" x 27 1/8"		2	0,52	23,5	3	0,58	44
	120 x 79 cm 47 2/8" x 31 1/8"		2	0,42	26,7	3	0,47	50,4
	150 x 79 cm 59" x 31 1/8"		2	0,53	29,8	3	0,60	56,6
	200 x 79 cm 78 6/8" x 31 1/8"		2	0,65	37	3	0,73	71

Tops

Laminate 10 mm thick

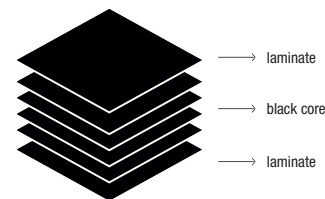
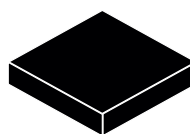

Pure-white 10 mm thick

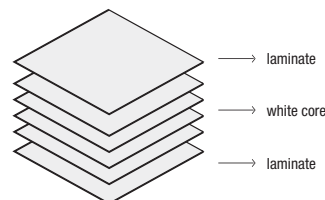
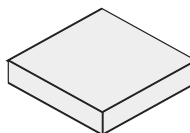

Fenix-NTM® black edge 10 mm thick

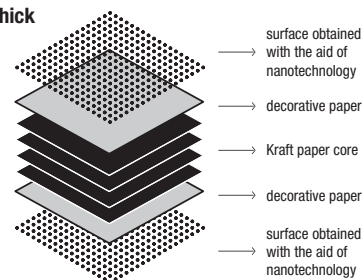
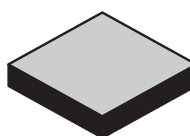

Stone 20 mm thick

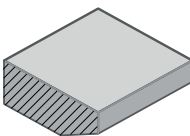

"Pietra di Fossena"

ELEPHANT TABLE

Table H. 75 cm - Fixed top

Leg finish:

Polished aluminium
 White lacquered aluminium (similar to RAL 9016)
 Black lacquered aluminium (similar to RAL 9004)

Finish of top:

Black laminate
 Pure-white laminate
 Fenix-NTM® black edge (Ingo black 0720)

Note:

For packaging specifications, see page 160-161.

Reinforced packaging, see inside cover.

Code	Dimensions	Legs	Top			pack	m ²	Kg
			Black laminate	Fenix-NTM®	Pure-white laminate			
01ELE01R	Ø 69	Lacquered aluminium						
		Polished aluminium						
01ELE01Q	69 x 69	Lacquered aluminium						
		Polished aluminium						
01ELE02R	Ø 79	Lacquered aluminium						
		Polished aluminium						
01ELE02Q	79 x 79	Lacquered aluminium						
		Polished aluminium						
01ELE03R	Ø 89	Lacquered aluminium						
		Polished aluminium						
01ELE03Q	89 x 89	Lacquered aluminium						
		Polished aluminium						

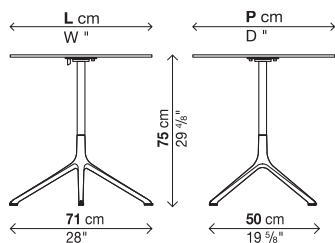

ELEPHANT TABLE

Table H. 76 cm - Tip-up top

Leg finish:

Polished aluminium

White lacquered aluminium (similar to RAL 9016)

Black lacquered aluminium (similar to RAL 9004)

Finish of top:

Black laminate

Pure-white laminate

Fenix-NTM® black edge (Ingo black 0720)

Note:

For packaging specifications, see page 160-161.

Reinforced packaging, see inside cover.

Code	Dimensions	Legs	Top			pack	m ²	Kg
			Black laminate	Fenix-NTM®	Pure-white laminate			
01ELE06R	Ø 69	Lacquered aluminium						
		Polished aluminium						
01ELE06Q	69 x 69	Lacquered aluminium						
		Polished aluminium						
01ELE07R	Ø 79	Lacquered aluminium						
		Polished aluminium						
01ELE07Q	79 x 79	Lacquered aluminium						
		Polished aluminium						
01ELE08R	Ø 89	Lacquered aluminium						
		Polished aluminium						
01ELE08Q	89 x 89	Lacquered aluminium						
		Polished aluminium						

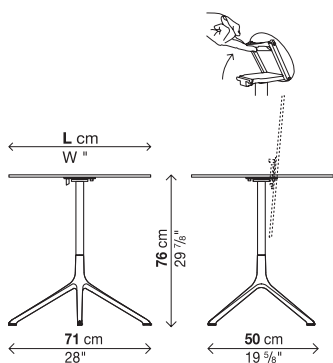

ELEPHANT TABLE

Table H. 75 cm - Fixed top

Leg finish:

Polished aluminium

White lacquered aluminium (similar to RAL 9016)

Black lacquered aluminium (similar to RAL 9004)

Finish of top:

Black laminate

Pure-white laminate

Fenix-NTM® black edge (Ingo black 0720)

Note:

For packaging specifications, see page 160-161.

Reinforced packaging, see inside cover.

Code	Dimensions	Legs	Top			pack	m ²	Kg
			Black laminate	Fenix-NTM®	Pure-white laminate			
01ELE20	100 x 59	Lacquered aluminium						
		Polished aluminium						
01ELE22	120 x 59	Lacquered aluminium						
		Polished aluminium						
01ELE21	100 x 69	Lacquered aluminium						
		Polished aluminium						
01ELE23	120 x 69	Lacquered aluminium						
		Polished aluminium						
01ELE25	150 x 69	Lacquered aluminium						
		Polished aluminium						
01ELE24	120 x 79	Lacquered aluminium						
		Polished aluminium						
01ELE26	150 x 79	Lacquered aluminium						
		Polished aluminium						
01ELE30	200 x 79	Lacquered aluminium						
		Polished aluminium						

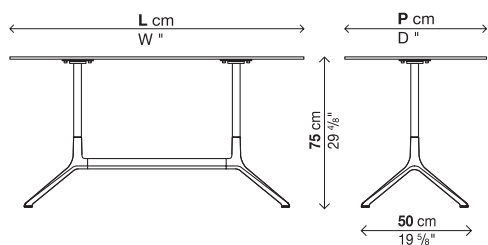

ELEPHANT TABLE

Table H. 76 cm - Tip-up top

Leg finish:

Polished aluminium

White lacquered aluminium (similar to RAL 9016)

Black lacquered aluminium (similar to RAL 9004)

Finish of top:

Black laminate

Pure-white laminate

Fenix-NTM® black edge (Ingo black 0720)

Note:

For packaging specifications, see page 160-161.

Reinforced packaging, see inside cover.

Code	Dimensions	Legs	Top			pack m ² Kg
			Black laminate	Fenix-NTM®	Pure-white laminate	
01ELE40	100 x 59	Lacquered aluminium				
		Polished aluminium				
01ELE42	120 x 59	Lacquered aluminium				
		Polished aluminium				
01ELE41	100 x 69	Lacquered aluminium				
		Polished aluminium				
01ELE43	120 x 69	Lacquered aluminium				
		Polished aluminium				
01ELE45	150 x 69	Lacquered aluminium				
		Polished aluminium				
01ELE44	120 x 79	Lacquered aluminium				
		Polished aluminium				
01ELE46	150 x 79	Lacquered aluminium				
		Polished aluminium				
01ELE50	200 x 79	Lacquered aluminium				
		Polished aluminium				

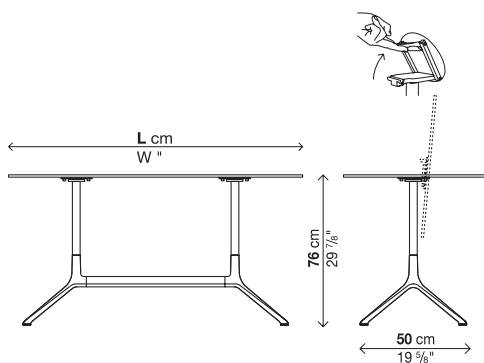

ELEPHANT TABLE

High table H. 105 cm - Fixed top

Leg finish:

Polished aluminium

White lacquered aluminium (similar to RAL 9016)

Black lacquered aluminium (similar to RAL 9004)

Finish of top:

Black laminate

Pure-white laminate

Fenix-NTM® black edge (Ingo black 0720)

Note:

For packaging specifications, see page 160-161.

Reinforced packaging, see inside cover.

Code	Dimensions	Legs	Top			pack	m ²	Kg
			Black laminate	Fenix-NTM®	Pure-white laminate			
01ELE04R	Ø 69	Lacquered aluminium						
		Polished aluminium						
01ELE04Q	69 x 69	Lacquered aluminium						
		Polished aluminium						
01ELE05R	Ø 79	Lacquered aluminium						
		Polished aluminium						
01ELE05Q	79 x 79	Lacquered aluminium						
		Polished aluminium						

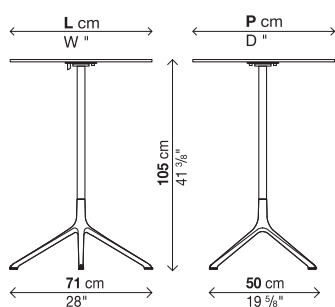

ELEPHANT TABLE

High table H. 106 cm - Tip-up top

Leg finish:

Polished aluminium

White lacquered aluminium (similar to RAL 9016)

Black lacquered aluminium (similar to RAL 9004)

Finish of top:

Black laminate

Pure-white laminate

Fenix-NTM® black edge (Ingo black 0720)

Note:

For packaging specifications, see page 160-161.

Reinforced packaging, see inside cover.

Code	Dimensions	Legs	Top			pack m ³ Kg
			Black laminate	Fenix-NTM®	Pure-white laminate	
01ELE09R	Ø 69	Lacquered aluminium				
		Polished aluminium				
01ELE09Q	69 x 69	Lacquered aluminium				
		Polished aluminium				
01ELE10R	Ø 79	Lacquered aluminium				
		Polished aluminium				
01ELE10Q	79 x 79	Lacquered aluminium				
		Polished aluminium				

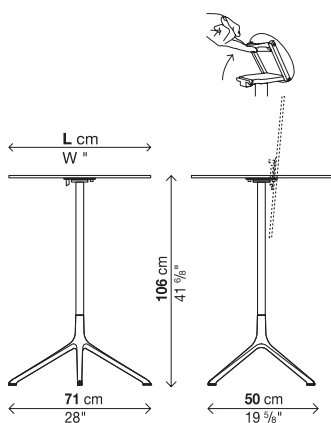

ELEPHANT TABLE

High table H. 105 cm - Fixed top

Leg finish:

Polished aluminium

White lacquered aluminium (similar to RAL 9016)

Black lacquered aluminium (similar to RAL 9004)

Finish of top:

Black laminate

Pure-white laminate

Fenix-NTM® black edge (Ingo black 0720)

Note:

For packaging specifications, see page 160-161.

Reinforced packaging, see inside cover.

Code	Dimensions	Legs	Top			pack	m ²	Kg
			Black laminate	Fenix-NTM®	Pure-white laminate			
01ELE60	100 x 59	Lacquered aluminium						
		Polished aluminium						
01ELE62	120 x 59	Lacquered aluminium						
		Polished aluminium						
01ELE61	100 x 69	Lacquered aluminium						
		Polished aluminium						
01ELE63	120 x 69	Lacquered aluminium						
		Polished aluminium						
01ELE64	150 x 69	Lacquered aluminium						
		Polished aluminium						

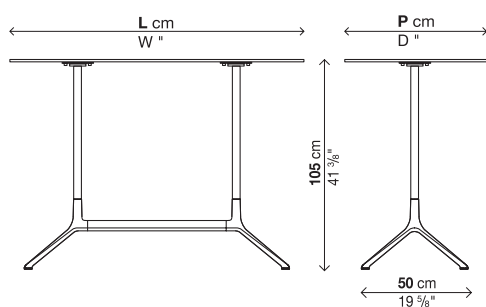

ELEPHANT TABLE

High table H. 106 cm - Tip-up top

Leg finish:

Polished aluminium

White lacquered aluminium (similar to RAL 9016)

Black lacquered aluminium (similar to RAL 9004)

Finish of top:

Black laminate

Pure-white laminate

Fenix-NTM® black edge (Ingo black 0720)

Note:

For packaging specifications, see page 160-161.

Reinforced packaging, see inside cover.

Code	Dimensions	Legs	Top			pack m³ Kg
			Black laminate	Fenix-NTM®	Pure-white laminate	
01ELE70	100 x 59	Lacquered aluminium				
		Polished aluminium				
01ELE72	120 x 59	Lacquered aluminium				
		Polished aluminium				
01ELE71	100 x 69	Lacquered aluminium				
		Polished aluminium				
01ELE73	120 x 69	Lacquered aluminium				
		Polished aluminium				
01ELE75	150 x 69	Lacquered aluminium				
		Polished aluminium				

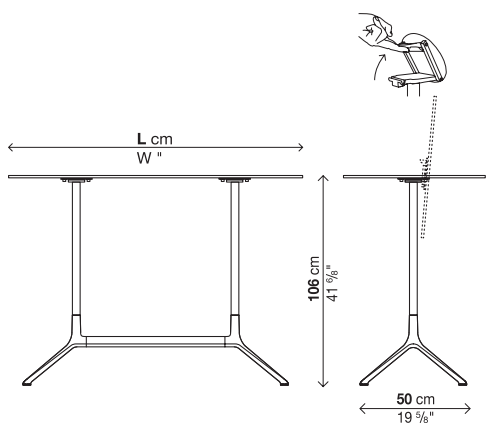

ELEPHANT TABLE

Occasional table H. 50 cm (laminated top), H. 51 cm (stone top)

Leg finish:

Polished aluminium

White lacquered aluminium (similar to RAL 9016)

Black lacquered aluminium (similar to RAL 9004)

Note:

For packaging specifications, see page 160-161.

Reinforced packaging, see inside cover.

Finish of top:

Black laminate

Pure-white laminate

Fenix-NTM® black edge (Ingo black 0720)

"Pietra di Fossena" stone

Code	Dimensions	Legs	Top				pack	m ³	Kg
			Black laminate	Fenix-NTM®	Pure-white laminate	"Pietra di Fossena" stone			
01ELE11R	Ø 69	Lacquered aluminium							
		Polished aluminium							
01ELE11Q	69 x 69	Lacquered aluminium							
		Polished aluminium							
01ELE12R	Ø 79	Lacquered aluminium				-			
		Polished aluminium				-			
01ELE12Q	79 x 79	Lacquered aluminium				-			
		Polished aluminium				-			
01ELE13R	Ø 89	Lacquered aluminium				-			
		Polished aluminium				-			
01ELE13Q	89 x 89	Lacquered aluminium				-			
		Polished aluminium				-			

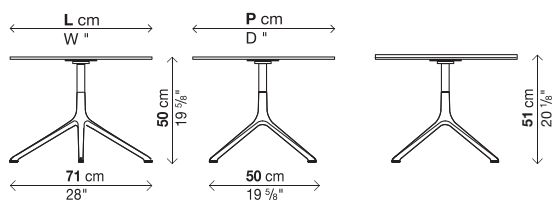

ELEPHANT TABLE

Occasional table H. 50 cm (laminated top), H. 51 cm (stone top)

Leg finish:

Polished aluminium
 White lacquered aluminium (similar to RAL 9016)
 Black lacquered aluminium (similar to RAL 9004)

Note:

For packaging specifications, see page 160-161.

Reinforced packaging, see inside cover.

Finish of top:

Black laminate
 Pure-white laminate
 Fenix-NTM® black edge (Ingo black 0720)
 "Pietra di Fossena" stone

Code	Dimensions	Legs	Top				pack m ³ Kg
			Black laminate	Fenix-NTM®	Pure-white laminate	"Pietra di Fossena" stone	
01ELE80	100 x 59	Lacquered aluminium				-	
		Polished aluminium				-	
01ELE81	120 x 59	Lacquered aluminium					
		Polished aluminium					
01ELE82	100 x 69	Lacquered aluminium				-	
		Polished aluminium				-	
01ELE83	120 x 69	Lacquered aluminium				-	
		Polished aluminium				-	
01ELE84	150 x 69	Lacquered aluminium				-	
		Polished aluminium				-	
01ELE85	120 x 79	Lacquered aluminium				-	
		Polished aluminium				-	
01ELE86	150 x 79	Lacquered aluminium				-	
		Polished aluminium				-	
01ELE87	200 x 79	Lacquered aluminium				-	
		Polished aluminium				-	

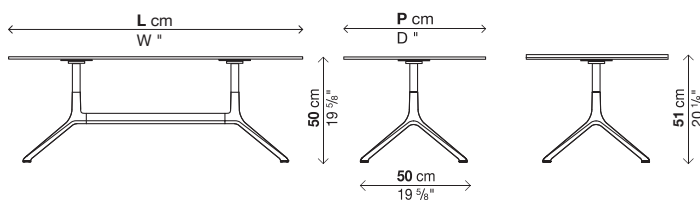

ELEPHANT TABLE

Occasional table H. 38 cm (laminated top) H. 39 cm (stone top)

Leg finish:

Polished aluminium

White lacquered aluminium (similar to RAL 9016)

Black lacquered aluminium (similar to RAL 9004)

Note:

For packaging specifications, see page 160-161.

Reinforced packaging, see inside cover.

Finish of top:

Black laminate

Pure-white laminate

Fenix-NTM® black edge (Ingo black 0720)

"Pietra di Fossena" stone

Code	Dimensions	Legs	Top				pack	m ²	Kg
			Black laminate	Fenix-NTM®	Pure-white laminate	"Pietra di Fossena" stone			
01ELE14R	Ø 69	Lacquered aluminium							
		Polished aluminium							
01ELE14Q	69 x 69	Lacquered aluminium							
		Polished aluminium							
01ELE15R	Ø 79	Lacquered aluminium				-			
		Polished aluminium				-			
01ELE15Q	79 x 79	Lacquered aluminium				-			
		Polished aluminium				-			
01ELE16R	Ø 89	Lacquered aluminium				-			
		Polished aluminium				-			
01ELE16Q	89 x 89	Lacquered aluminium				-			
		Polished aluminium				-			

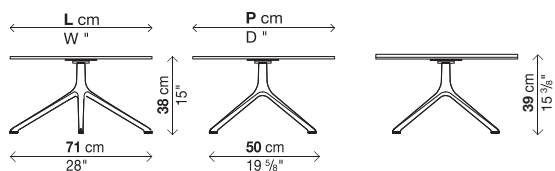

ELEPHANT TABLE

Occasional table H. 38 cm (laminated top) H. 39 cm (stone top)

Leg finish:

Polished aluminium
 White lacquered aluminium (similar to RAL 9016)
 Black lacquered aluminium (similar to RAL 9004)

Note:

For packaging specifications, see page 160-161.

Reinforced packaging, see inside cover.

Finish of top:

Black laminate
 Pure-white laminate
 Fenix-NTM® black edge (Ingo black 0720)
 "Pietra di Fossena" stone

Code	Dimensions	Legs	Top				pack m ³ Kg
			Black laminate	Fenix-NTM®	Pure-white laminate	"Pietra di Fossena" stone	
01ELE88	100 x 59	Lacquered aluminium				-	
		Polished aluminium				-	
01ELE89	120 x 59	Lacquered aluminium					
		Polished aluminium					
01ELE90	100 x 69	Lacquered aluminium				-	
		Polished aluminium				-	
01ELE91	120 x 69	Lacquered aluminium				-	
		Polished aluminium				-	
01ELE92	150 x 69	Lacquered aluminium				-	
		Polished aluminium				-	
01ELE93	120 x 79	Lacquered aluminium				-	
		Polished aluminium				-	
01ELE94	150 x 79	Lacquered aluminium				-	
		Polished aluminium				-	
01ELE95	200 x 79	Lacquered aluminium				-	
		Polished aluminium				-	

