

interstuhl

Goal-Air

Bedienungsanleitung
Operating instructions
Mode d'emploi
Gebruiksaanwijzing
Instrucciones de uso
Istruzioni d'uso

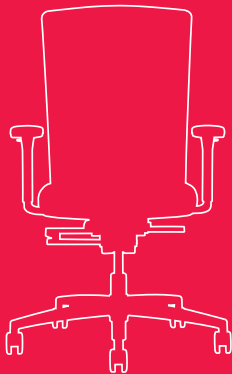

Montage, Rollen, Stuhlsäule und Rückenlehne

Assembly, castors, chair column and backrest

Montage, roulettes, vérin et dossier

Montage, wielen, gasveer en rugleuning

Montaje, ruedas, pistón de gas y respaldo

Montaggio, ruote colonna centrale, pistone a gas con schienale

1.

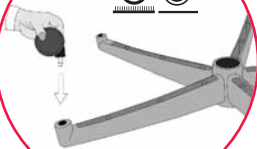

2.



3.

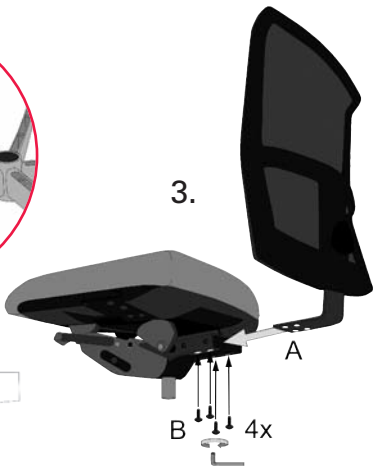

Montage, Armlehnen

Assembly, armrests

Montage, accoudoirs

Montage, armleggers

Montaje, brazos

Montaggio, braccioli

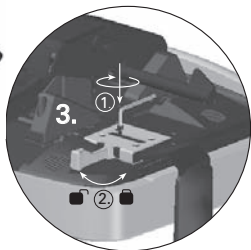
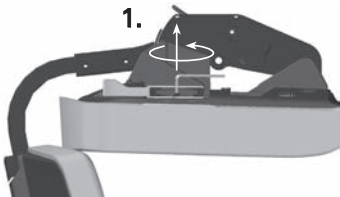



Sitzhöhenverstellung

Seat height adjustment

Réglage de la hauteur d'assise

Zithoogteverstelling

Regulación de altura del asiento

Regolazione altezza seduta





Synchronmechanik

Synchronous mechanism

Mécanisme synchrone

Synchroontechniek

Mecanismo sincronizado

Meccanismo syncro



180°



Gewichtsregulierung

Weight adjustment

Réglage de tension

Gewichtsregeling

Regulación de peso

Regolazione peso

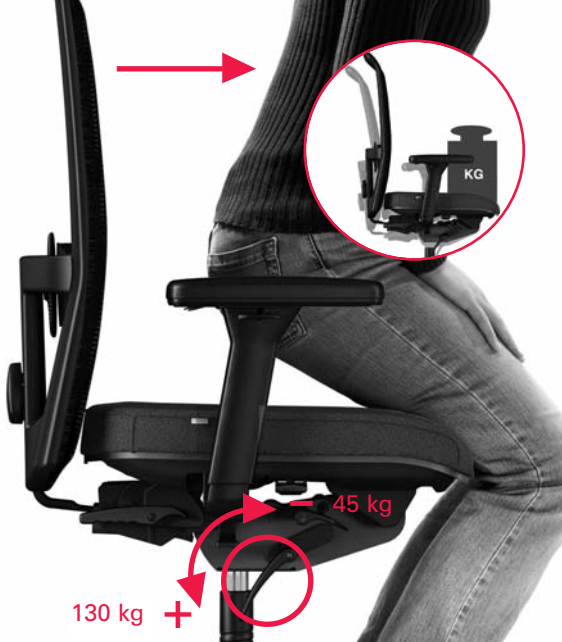

45 kg

130 kg +



Lordosenstütze (Option)

Lumbar support (option)

Soutien lombaire (option)

Lendensteun (optie)

Apoyo lumbar (opción)

Supporto lombare (opzione)





Rückenlehnen-Höhenverstellung

Back height adjustment

Dossier réglable en hauteur

Rugleuning in hoogte verstelbaar

Regulación de altura del respaldo

Regolazione altezza schienale





Sitztiefenverstellung (Option)

Seat depth adjustment (option)

Réglage de la profondeur d'assise (option)

Zitdiepteverstelling (optie)

Regulación de la profundidad del asiento (opción)

Regolazione profondità seduta (opzione)





Sitzneigeverstellung (Option)

Seat inclination adjustment (option)

Réglage de l'inclinaison d'assise (option)

Zitneigeverstelling (optie)

Regulación de la inclinación del asiento (opción)

Regolazione inclinazione seduta (opzione)





Höhenverstellung der Armlehnen

Height adjustable armrests

Accoudoirs réglables en hauteur

Hoogteverstelling van de armleggers

Regulación de la altura de los brazos

Regolazione altezza braccioli





Breitenverstellung der Armlehnen

Width adjustable armrests

Accoudoirs réglables en largeur

Breedteverstelling van de armleggers

Regulación del ancho de los brazos

Regolazione larghezza braccioli

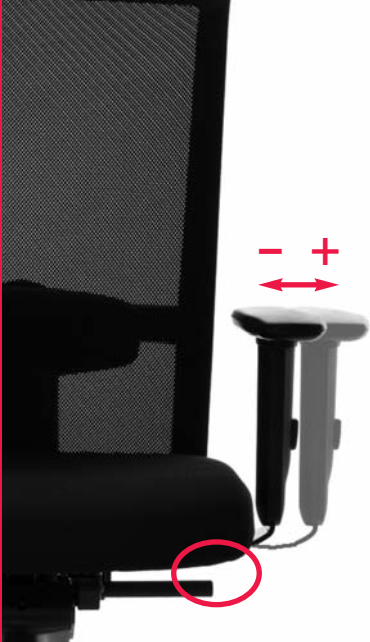



4D Armlehnen

4D armrests

4D accoudoirs

4D armleggers

4D brazos

4D braccioli

Tiefenverstellung der Armauflage

Adjustable arm supports

Manchettes réglables en profondeur

Armleggeropdek in diepte verstelbaar

Superficie de apoyo de los brazos regulable en profundidad

Regolazione parte superiore braccioli





4D Armlehnen

4D armrests

4D accoudoirs

4D armleggers

4D brazos

4D braccioli

Armauflage schwenkbar

Swivel arm support

Manchettes pivotantes

Armleggeropdek zwenkbaar

Brazos retrotraibles

Parte superiore del bracciolo girevole

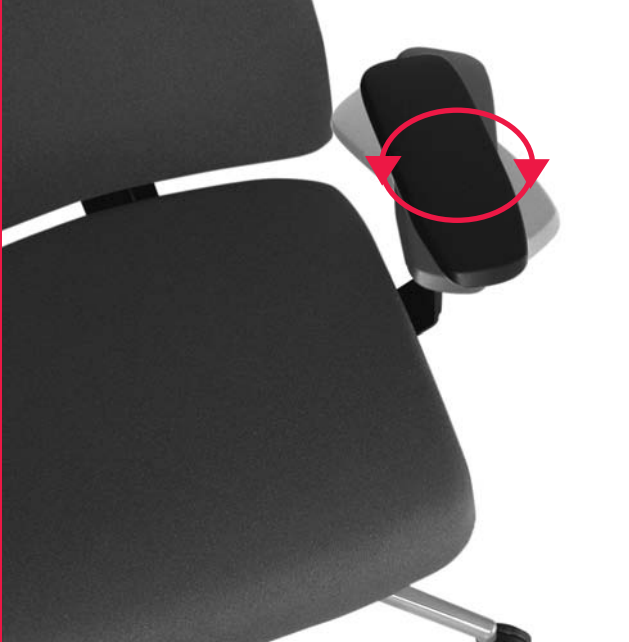



175G

165G

Kopfstütze - Höhenverstellung

Headrest - height adjustment

Repose-tête - réglage en hauteur

Hoofdsteun - hoogteverstelling

Reposacabezas - regulación de altura

Poggiatesta - regolazione altezza





175G

165G

Kopfstütze - Tiefenverstellung

Headrest - depth adjustment

Repose-tête - réglage de la profondeur

Hoofdsteen - diepteverstelling

Reposacabezas - regulación de la profundidad

Poggiatesta - regolazione profondità



www.interstuhl.de

Interaktive Bedienungsanleitung
Interactive operating instructions
Mode d'emploi interactif
Interactieve gebruiksaanwijzing
Instrucciones de uso interactivo
Istruzioni d'uso interattive

Hinweise zu Reinigung, Pflege und Rollenauswahl
Cleaning, maintenance instructions and castor options
Informations pour le nettoyage, l'entretien et le choix
de roulettes
Mantenimiento, manual de instrucciones y opciones
de ruedas
Aanwijzing voor reiniging, onderhoud en wielkeuze
Informazioni sulla pulizia, la manutenzione e la
selezione delle ruote

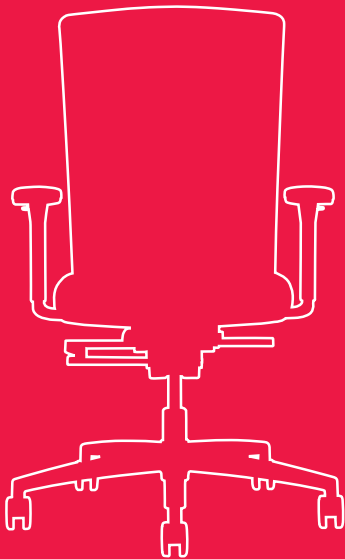

Gasfeder

Der Austausch bzw. das Arbeiten an der Gasfeder ist nur durch geschultes Fachpersonal durchzuführen.

Gas spring

Only trained, specialized staff may be allowed to replace or carry out work on the gas spring.

Vérin

Tout changement ou tous travaux sur le vérin à gaz ne doivent être effectués que par du personnel spécialisé et qualifié.

Gasveer

Alleen daarvoor opgeleide vakmensen mogen de gasveer vervangen resp. werkzaamheden aan de gasveer verrichten.

Resortes a gas

Los recambios y trabajos de los resortes a gas se deberán exclusivamente por personal especializado instruido en la materia.

Pompa a Gas

Solo staff specializzato può essere autorizzato a farce manutenzione sulla pompa a gas.



Qualitätszertifikate
Quality certificates
Certificats de qualité
Kwaliteitscertificaten
Certificados de calidad
Certificati di Qualità

Der Hersteller haftet nicht für Schäden aus unsachgemäßem Gebrauch oder aus Nachlässigkeiten in der Wartung. Im Rahmen des GS-Zeichens werden Bürostühle mit einer Belastung, die 120 kg Körpergewicht entspricht, geprüft.

The manufacturer is not liable for damages due to improper use or negligence of maintenance. The GS-Certificate proves that office chairs are able to carry the body weight of 120 kilo gram.

Le fabricant n'est pas responsable de dommages résultant d'une utilisation non conforme du produit et de dommages résultant d'opérations de maintenance. Dans le cadre du Certificat GS, les sièges de bureau supportent une charge de 120 kg.

De fabrikant is niet aansprakelijk voor schades die ontstaan door oneigenlijk gebruik of nalatigheid in het onderhoud. Conform het GS-certificaat (gecontroleerde veiligheid) worden kantoor - draaistoelen getest met een belasting die overeenkomt met 120 kg lichaamsgewicht.

El fabricante no se responsabiliza de posibles daños causados a raíz de un uso indebido del producto o de negligencias en el mantenimiento. El certificado GS demuestra que las sillas de oficina son capaces de aguantar un peso corporal de 120 Kg.

Il produttore non è responsabile per danni dovuti ad un uso improprio o a negligenza nella manutenzione della merce. Il certificato GS prova che le sedie per ufficio hanno una portata massima di peso corporeo pari a 120 Kg.

172G/
162G o. Abb.



175G/
165G o. Abb.



Goal-Air Bürodrehstühle

Goal-Air swivel chairs

Goal-Air sièges de bureau pivotants

Goal-Air draaistoelen

Goal-Air sillas giratorias de oficina

Goal-Air sedia girevole

570G/
575G o. Abb.



580G/
585G o. Abb.



Goal-Air Besucherstühle
Goal-Air visitor chairs
Goal-Air sièges visiteur
Goal-Air bezoekerstoelen
Goal-Air sillas para de visitas
Goal-Air seduta per visitatore

Interstuhl

Büromöbel GmbH & Co. KG

Brühlstraße 21

72469 Meßstetten-Tieringen, Germany

Phone +49 -7436-871-0

Fax +49 -7436-871-110

info@interstuhl.de

www.interstuhl.de