

Zinta / Lounge

Design by Lievore Altherr Molina, 2014

Modular seat components with oak-effect plywood shell, available in several colors. Steel frame and aluminum legs are both lacquered in anthracite color. The shell is provided with cushions upholstered in fabric, leather, faux leather or customer's fabric applied on both seat and backrest or only on the seat. Modules can be combined to create linear or L-shaped arrangements. Armrests and cushions for angular compositions are available upon request and can be ordered separately.



Shipment Details

Art. 4401 / 4419		
1 pz = 1 box	kg 41 / m ³ 0.57	lb 90.4 / ft ³ 20.129
Art. 4402 / 4403 / 4420		
1 pz = 1 box	kg 53 / m ³ 0.86	lb 116.8 / ft ³ 30.371
Art. 4404 / 4405 / 4421		
1 pz = 1 box	kg 85 / m ³ 1.30	lb 187.4 / ft ³ 45.909
Art. 4406 / 4407 / 4422		
1 pz = 1 box	kg 52 / m ³ 1.30	lb 114.6 / ft ³ 45.909
Art. 4408 / 4409 / 4423		
1 pz = 1 box	kg 52 / m ³ 1.30	lb 114.6 / ft ³ 45.909
Art. 4410 / 4411 / 4424		
1 pz = 1 box	kg 60 / m ³ 1.05	lb 132.3 / ft ³ 37.080
Art. 4412 / 4413 / 4425		
1 pz = 1 box	kg 60 / m ³ 1.05	lb 132.3 / ft ³ 37.080
Art. 4414 / 4415 / 4426		
1 pz = 1 box	kg 78 / m ³ 1.24	lb 172.0 / ft ³ 43.790

Base finishes



V44
Anthracite
lacquered

Shell finishes



L0022
Natural oak
wood



L0023
Teak effect
wood



L0006
Black wood

Materials

Carded In fabrics by **kvadrat** and No Stain



Topas 2

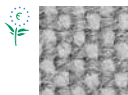

Hallingdal 65



Remix 2



Cava 3



Pro 2



Clara 2



Tempo



Divina MD



Scuba



No Stain



Divina 3



Divina
Melange 2



Tonus 3



Field



Steelcut Trio 2



Sunniva



Steelcut 2



Pause 4



Canvas

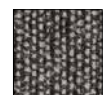

Savanna

Zinta / Lounge

Design by Lievore Altherr Molina, 2014

Carded In Soft leather, Faux leather and Chrome Free leather by **elmo**.



PI
Faux leather



PF
Soft leather



ES
Soft leather
Elmosoft®

Graded In fabrics by

kvadrat

www.kvadrat.dk

camira

www.camirafabrics.com



www.fidivi.com

Gabriel

www.gabriel.dk



www.spradling.eu

climatex

www.climatex.com

Serge Ferrari

www.en.sergeferrari.com



www.winter-creation.com

**DESIGN
TEX**

www.designtex.com

maharam

www.maharam.com

Visit the company website www.arper.com to view the available fabrics and swatches

Accessories

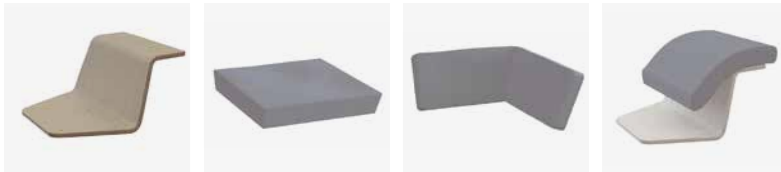



1 2 3 4

- 1 Armrest
- 2 Seat cushion angle 90°
- 3 Backrest cushion angle 90°
- 4 Armrest cushion

Zinta / Lounge

Design by Lievore Altherr Molina, 2014

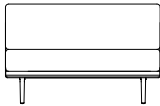
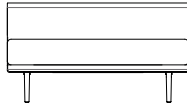
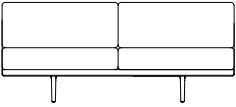
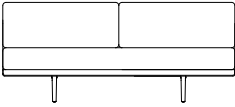
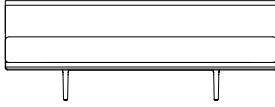
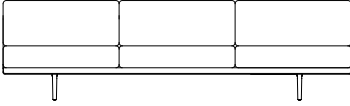
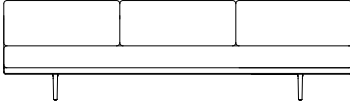
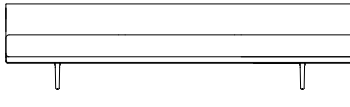
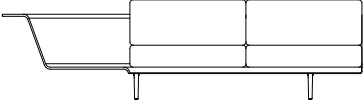
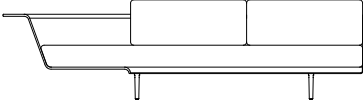
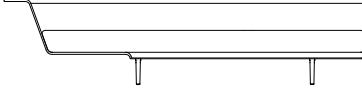
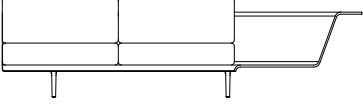
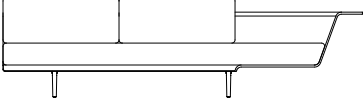
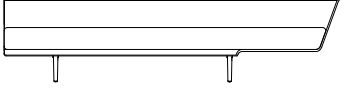
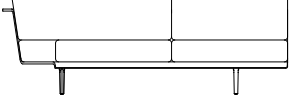
MODULAR SYSTEM

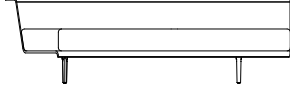
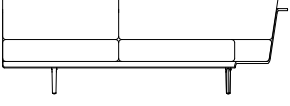
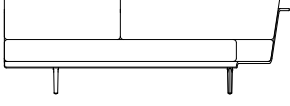
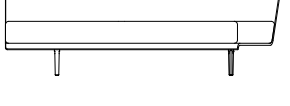
CUSCINI MODULARI SEDILE + CUSCINI MODULARI SCHIENALE	CUSCINO SINGOLO SEDILE + CUSCINO MODULARE SCHIENALE	CUSCINO SINGOLO SEDILE
	 Art. 4401	 Art. 4419
 Art. 4402	 Art. 4403	 Art. 4420
 Art. 4404	 Art. 4405	 Art. 4421
 Art. 4406	 Art. 4407	 Art. 4422
 Art. 4408	 Art. 4409	 Art. 4423
 Art. 4410	 Art. 4411	 Art. 4424
 Art. 4412	 Art. 4413	 Art. 4425

arper

F +39 0422 791800

T +39 0422 7918

www.arper.com

* Dimensions and files CAD 2D - 3D available for download at www.arper.com

Zinta / Lounge

Design by Lievore Altherr Molina, 2014

MODULAR SYSTEM

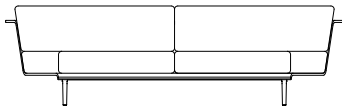
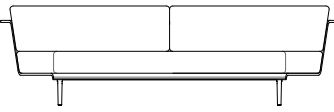
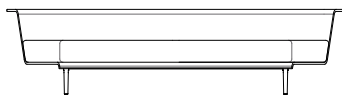
MODULAR SEAT CUSHIONS + MODULAR BACK CUSHIONS	1 SEAT CUSHION + 1 BACK CUSHION	SINGLE SEAT CUSHION
 <p>Art. 4414</p>	 <p>Art. 4415</p>	 <p>Art. 4426</p>

arper

F +39 0422 791800

T +39 0422 7918

www.arper.com

* Dimensions and files CAD 2D - 3D available for download at www.arper.com